

HIGH-DENSITY FOAM COSTUMES

**8 GREAT
TECHNIQUES
INSIDE!**

And find more
tips and tricks
(and templates too!)
at hobbylobby.com.



HOBBY LOBBY®



IN SHINING ARMOR

From sword to shield (and the armor in between), high-density foam turns fantasy into reality!

Tip: Use thick foam (10mm) for the main pieces and thin foam (3mm, 5mm) for the detailing.



High-density foam
before embellishing.

First apply primer.

Then dry-brush with
dark paint. Let dry.

Paint over with lighter color,
keeping paint blotchy and
cloudy for weathered look.



WEATHERING

Dry-brush dark and light paints over one another to create a weathered look. Psst... Leave edges darker and add imperfections to create realistic dimension.

Spotchy shading around the corners and edges enhances the weathered aesthetic.



STRAPPING

Leather straps (like the ones on the back of this shield) must be reinforced at both ends with foam tabs. This method ensures the straps stay secure during use.

STEP 1

Cut leather straps and reinforcing foam tabs.



STEP 2

Secure leather straps with rubber cement (this adhesive only sticks to itself, so it must be applied to both the straps and the foam).



STEP 3

Secure foam tabs with rubber cement.



STEP 4

Be sure to leave some slack in the straps—you'll need to create gaps for holding.



Knight Template Guide

- For a full size template, cut out all pieces.
- Align arrow ends and tape template together.
- Size fits youth 8-10 years old.
- Scale to desired size.

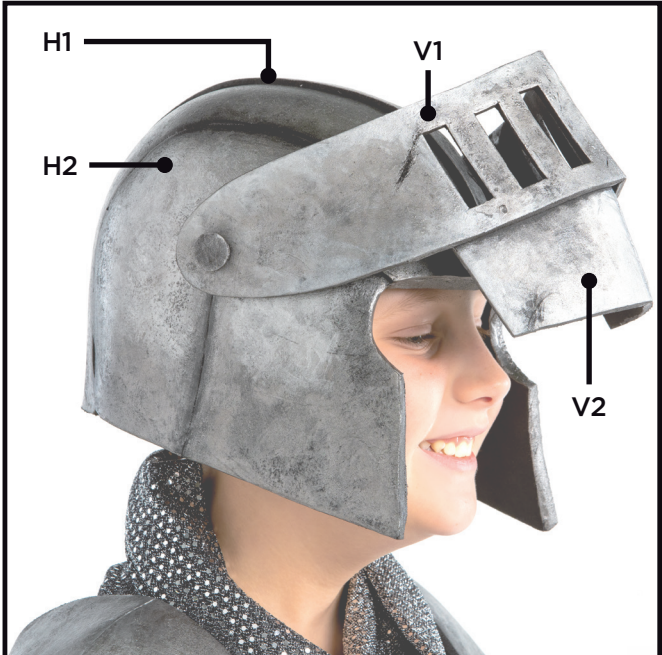
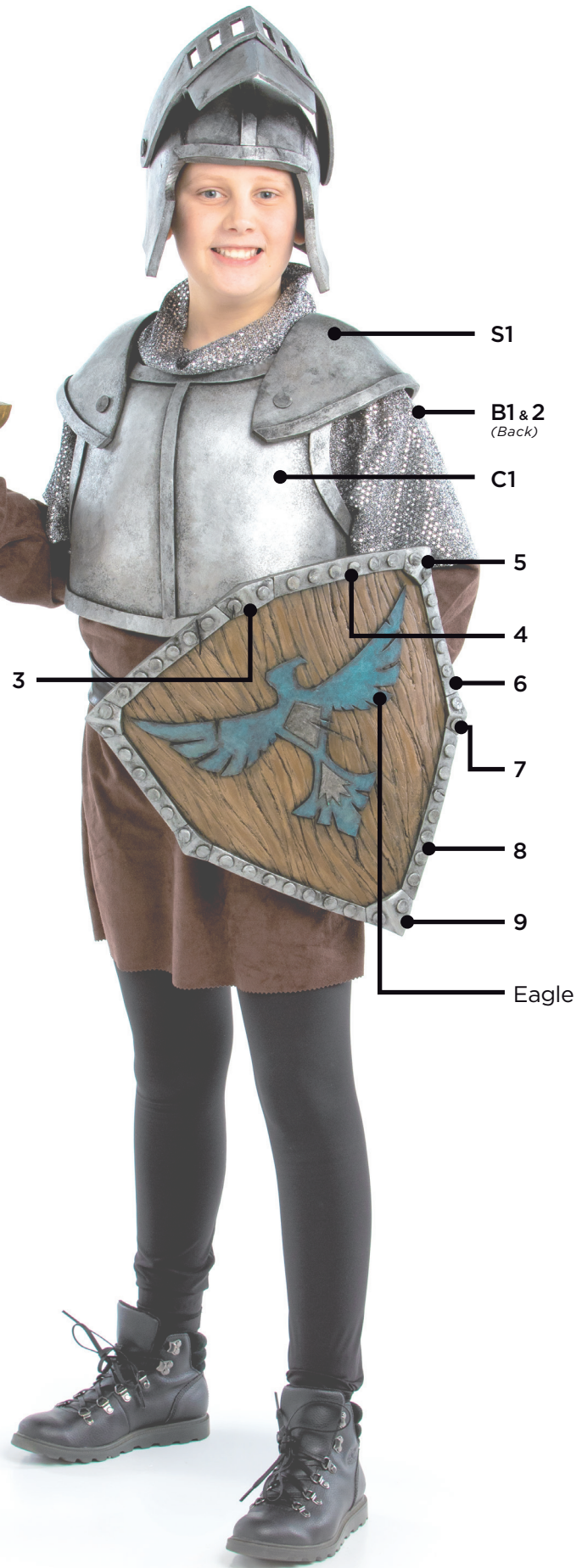
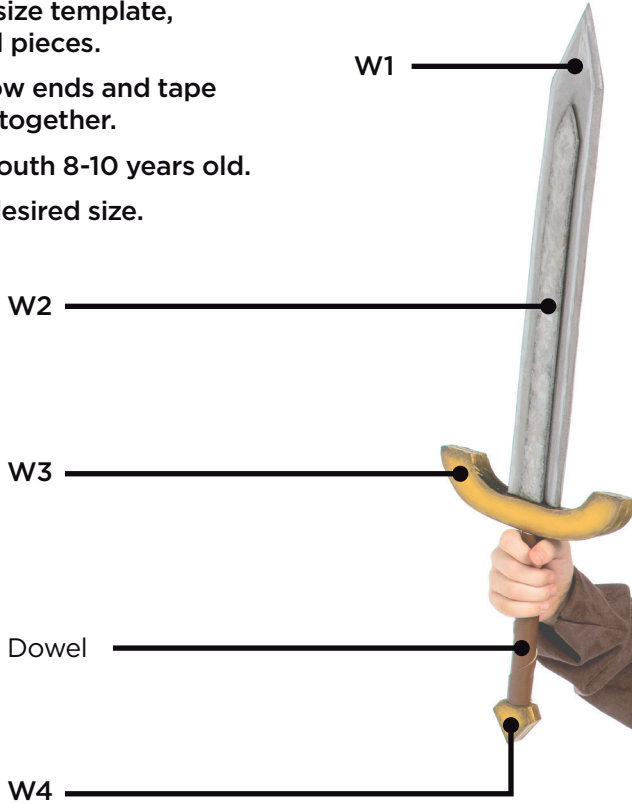

Knight Template A

See *Knight Template Guide* for instructions.

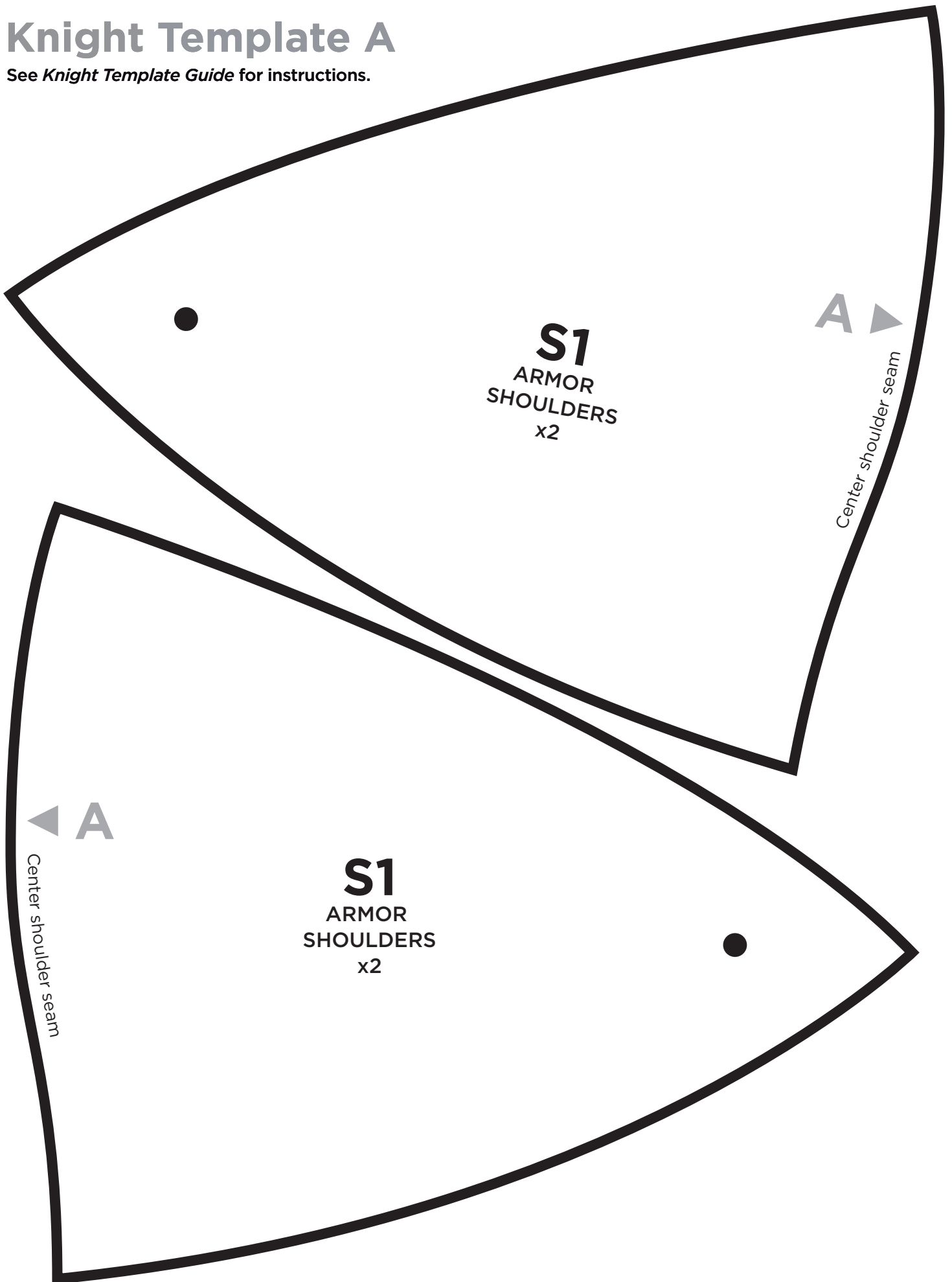

Knight Template B

See *Knight Template Guide* for instructions.

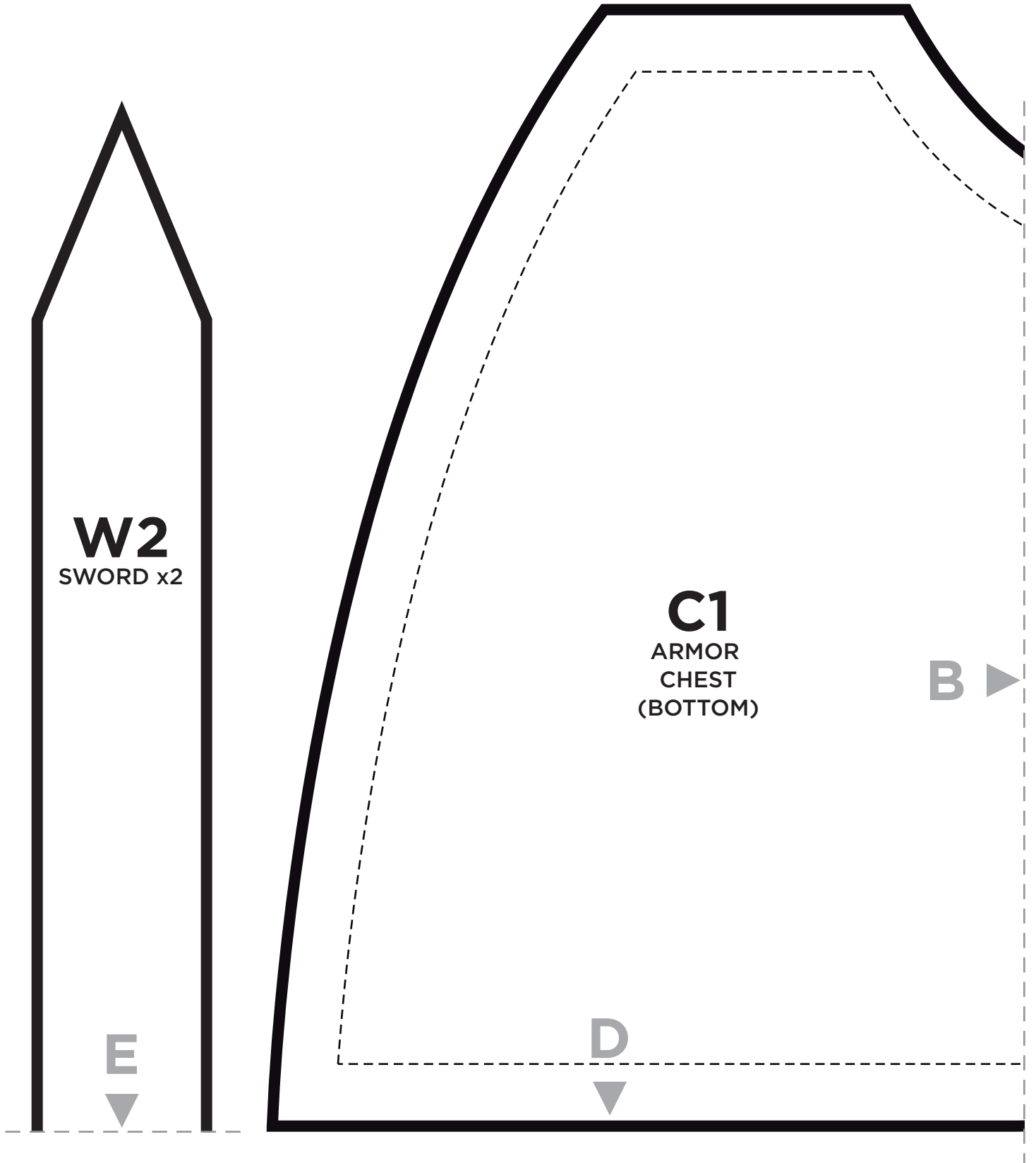

Knight Template C

See *Knight Template Guide* for instructions.

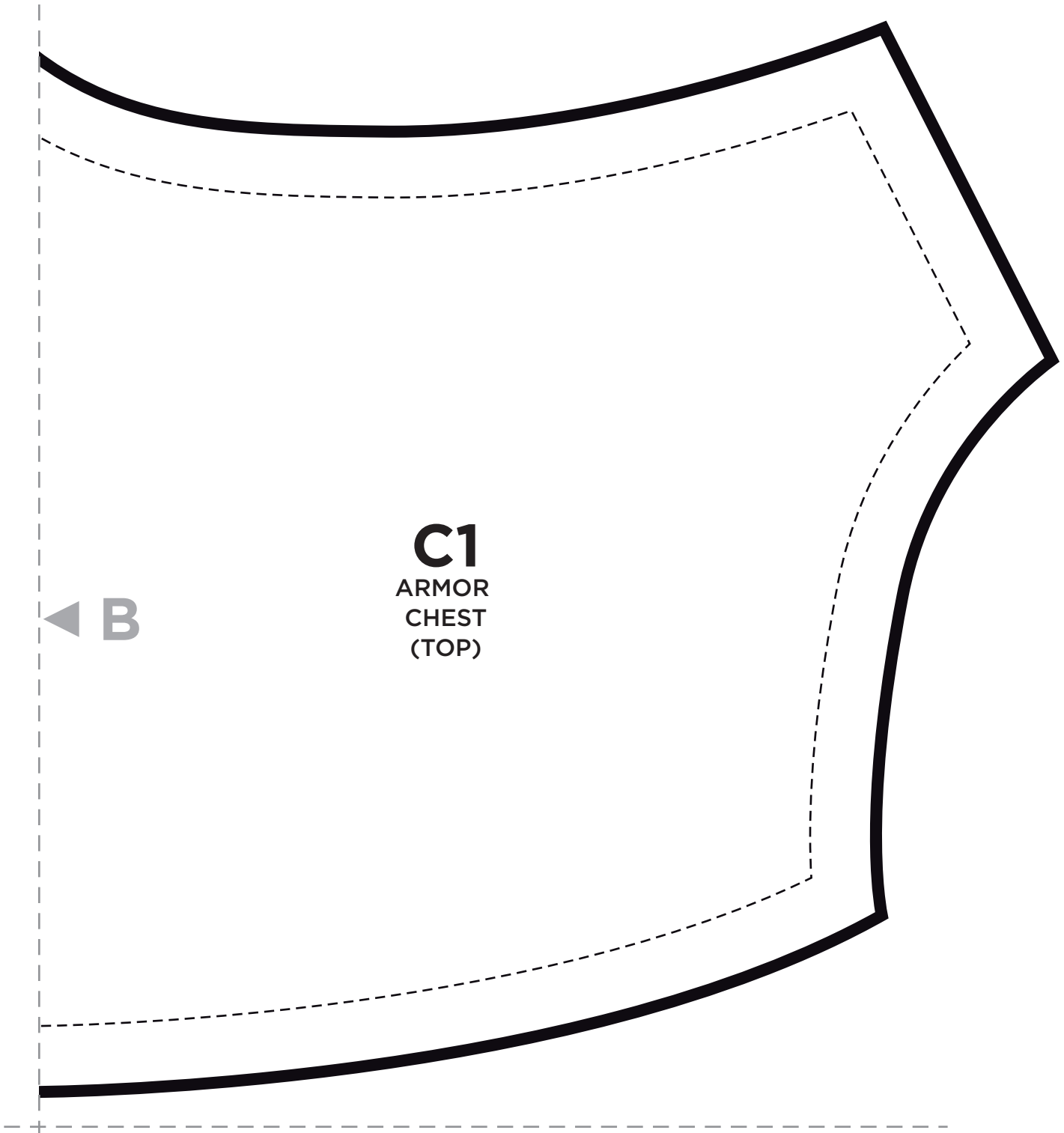

Knight Template D

See *Knight Template Guide* for instructions.

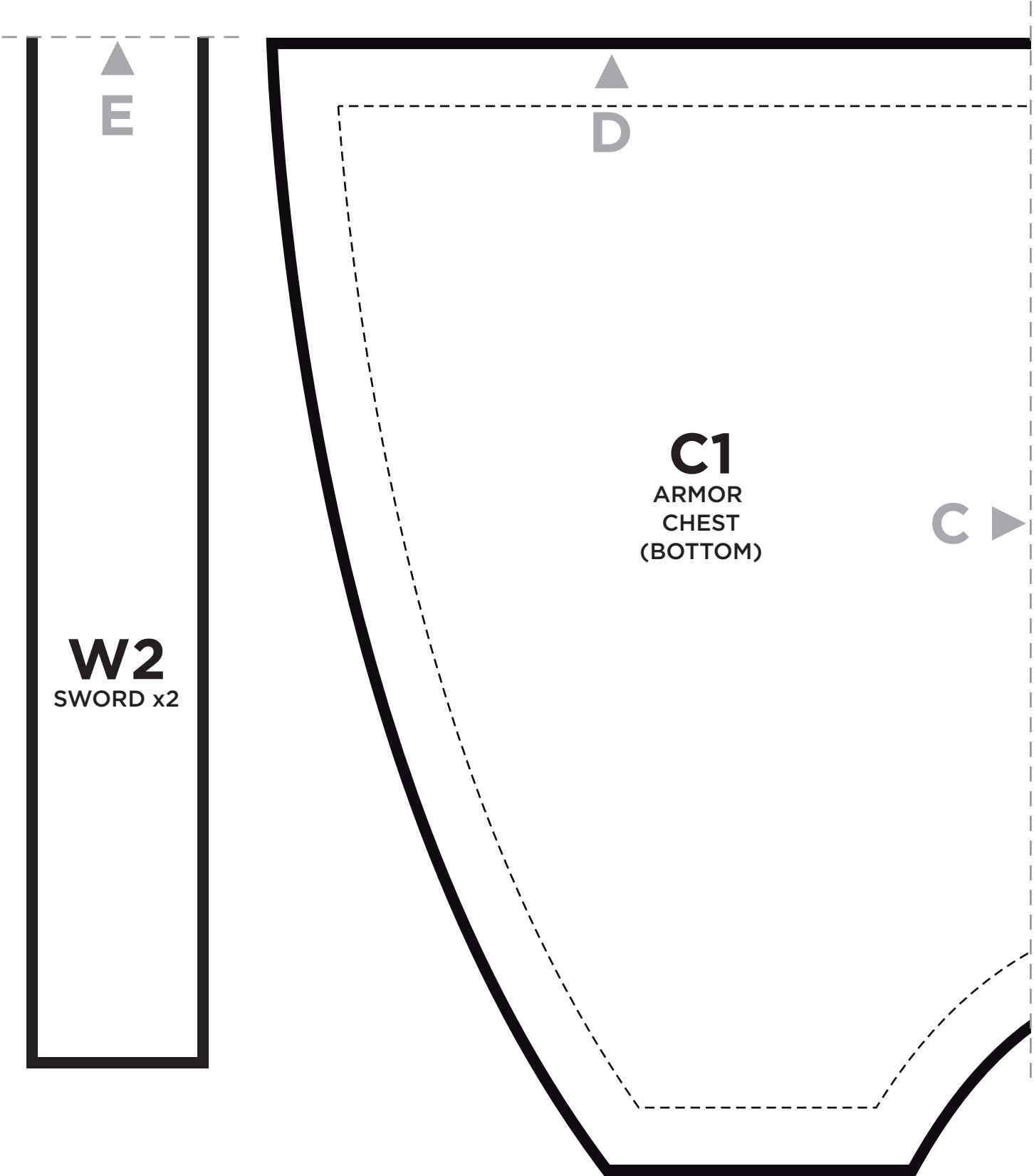

Knight Template E

See *Knight Template Guide* for instructions.

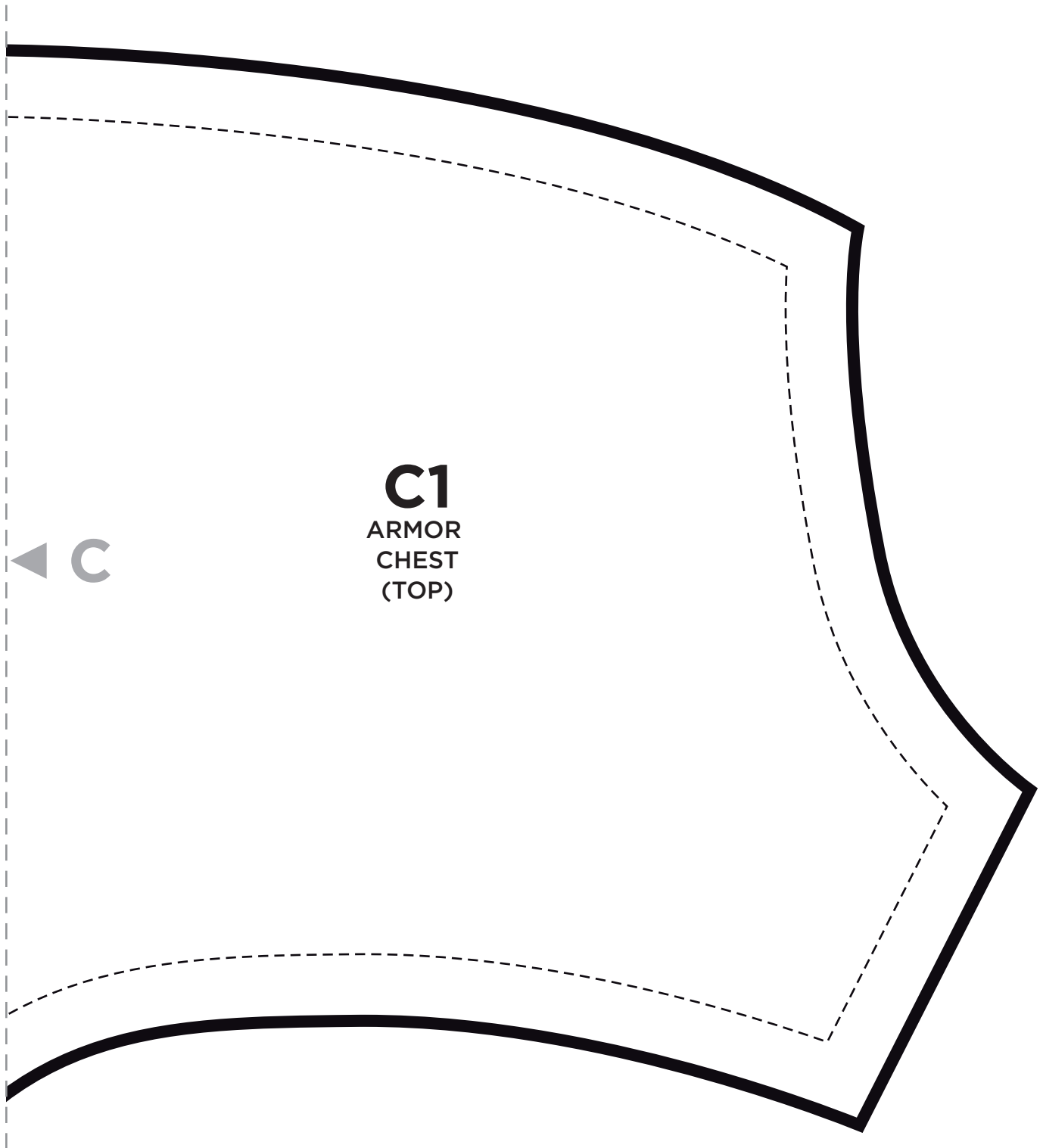

Knight Template K

See *Knight Template Guide* for instructions.

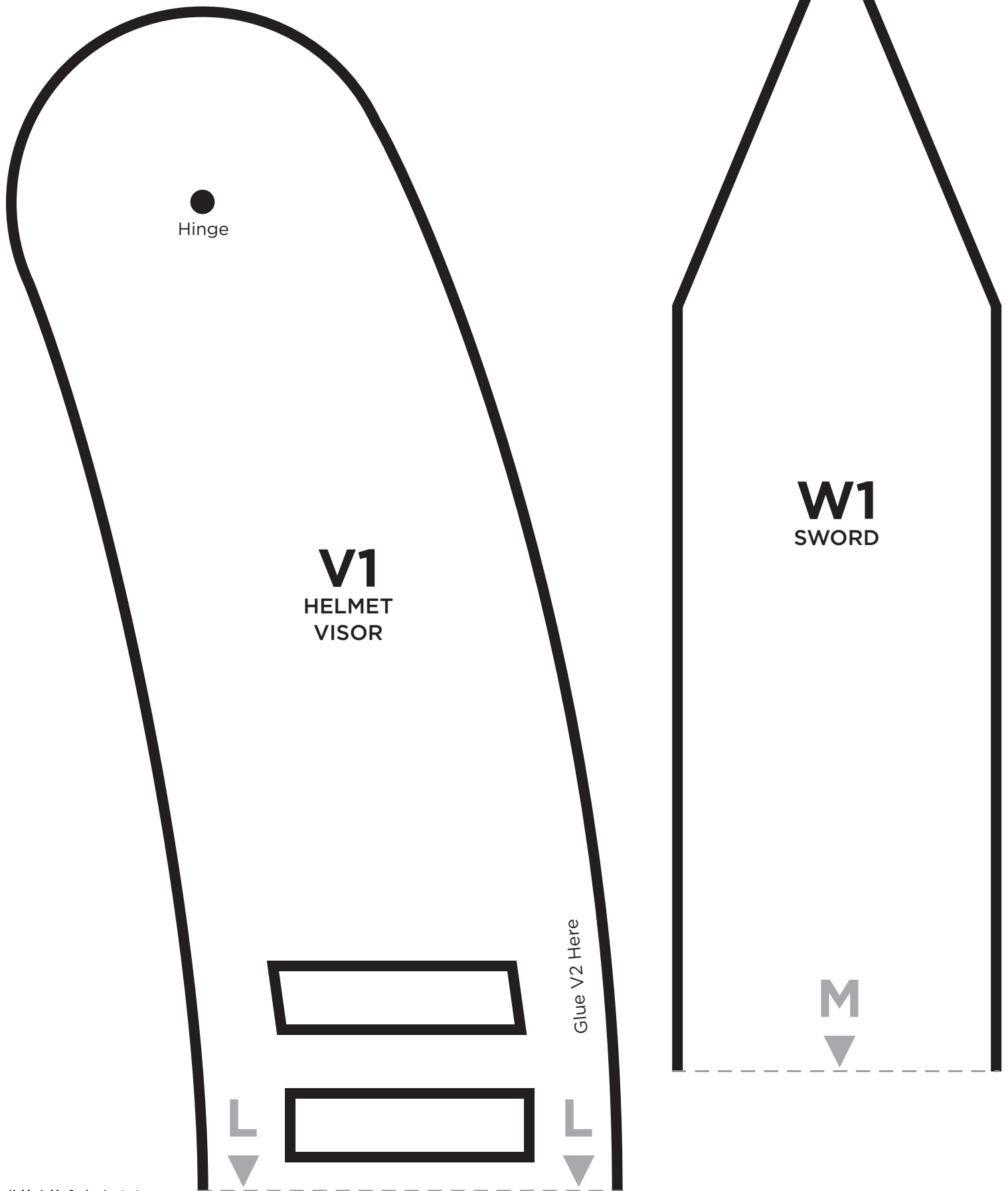

Knight Template L

See *Knight Template Guide* for instructions.

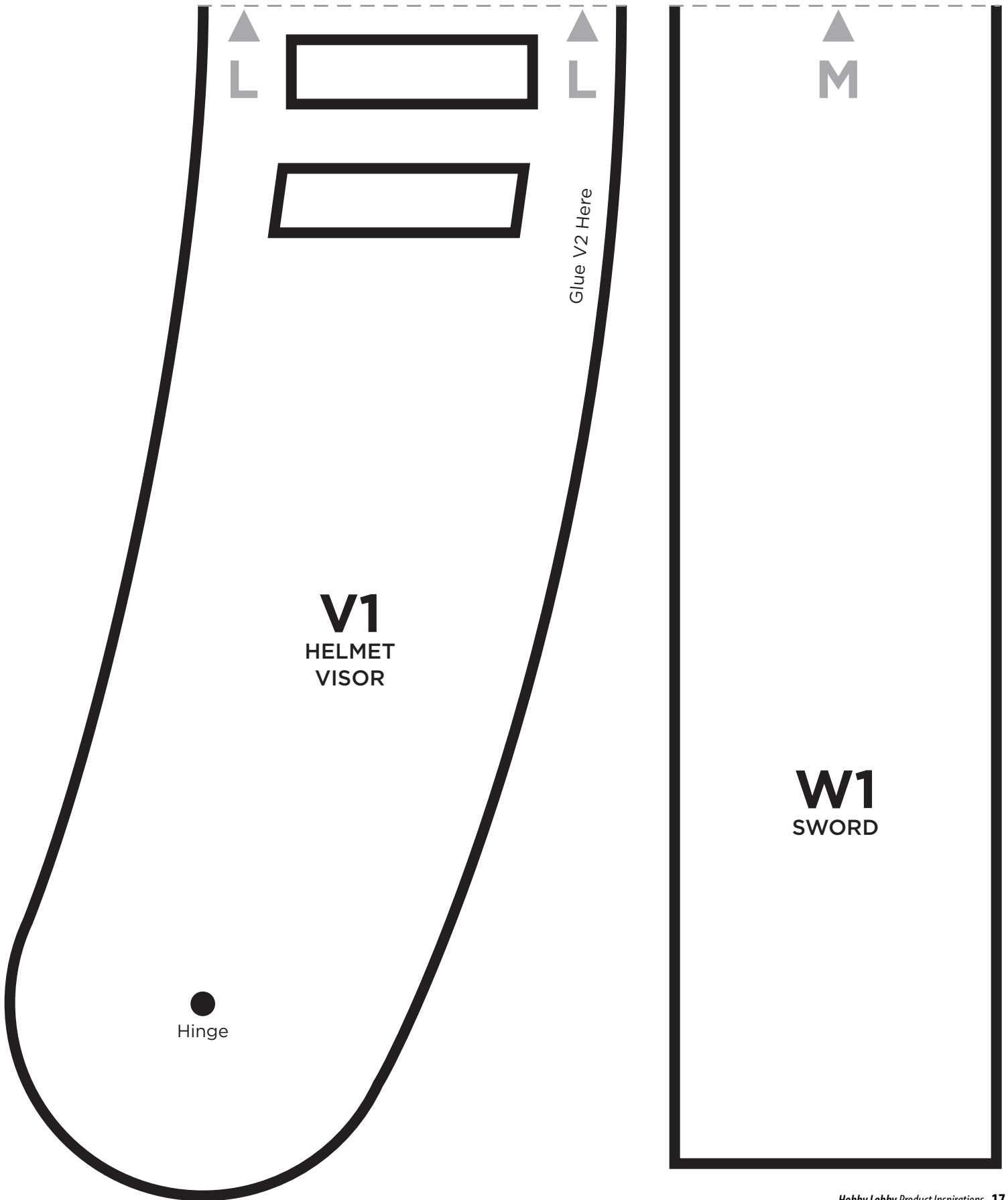

Knight Template M

See *Knight Template Guide* for instructions.

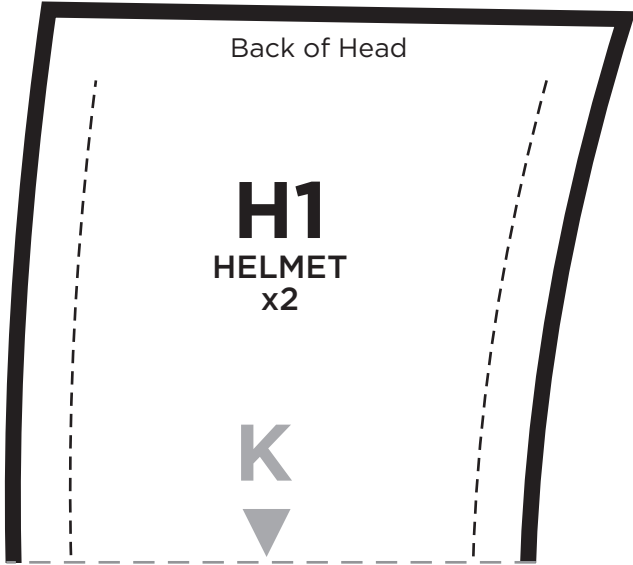
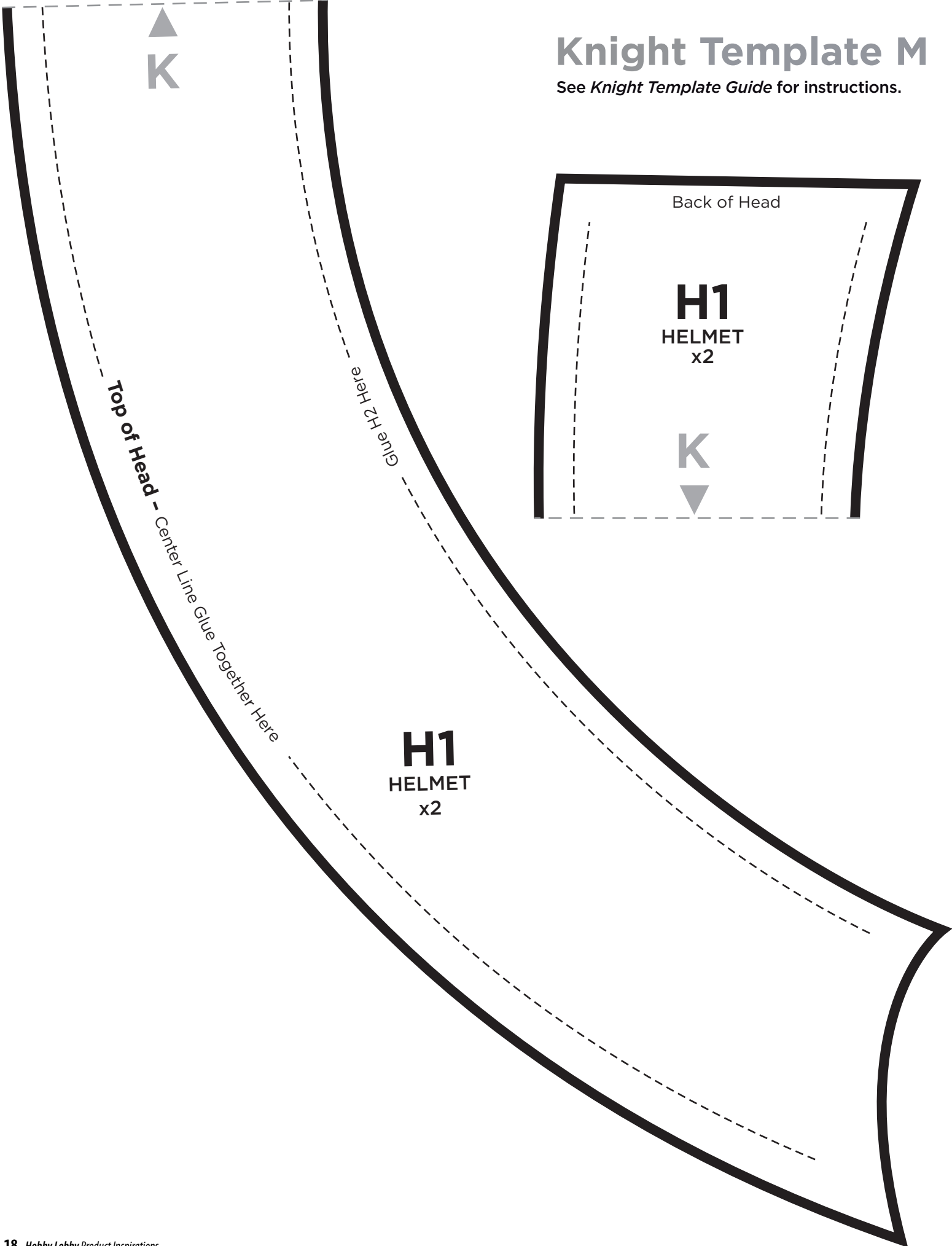

Knight Template N

See *Knight Template Guide* for instructions.

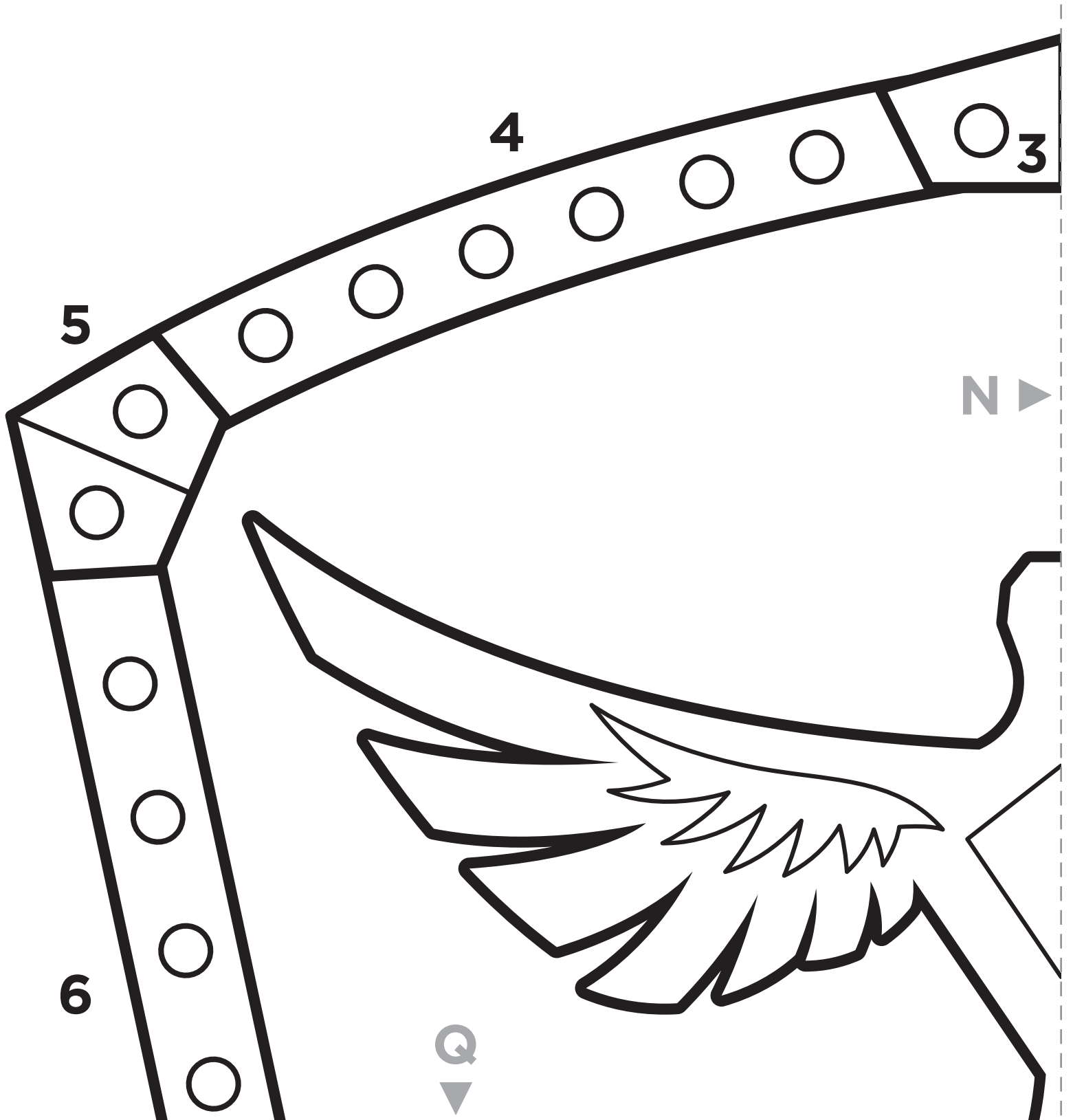

Knight Template F

B1
ARMOR
BACK

F ▶

Glue B2 Here

G
▼

See *Knight Template Guide* for instructions.

Knight Template G

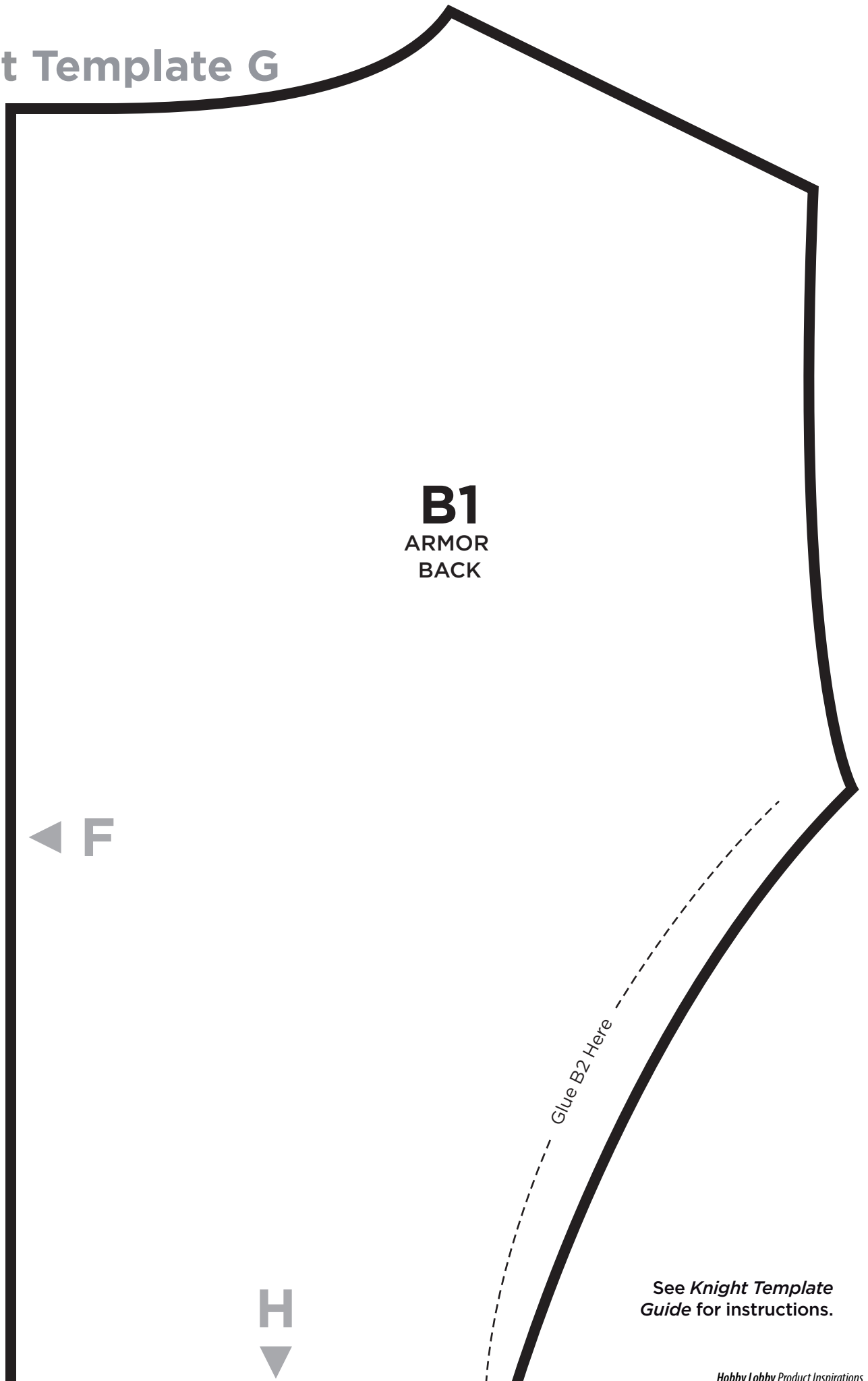

B1
ARMOR
BACK

◀ **F**

H
▼

Glue B2 Here

*See Knight Template
Guide for instructions.*

Knight Template H

See *Knight Template Guide* for instructions.

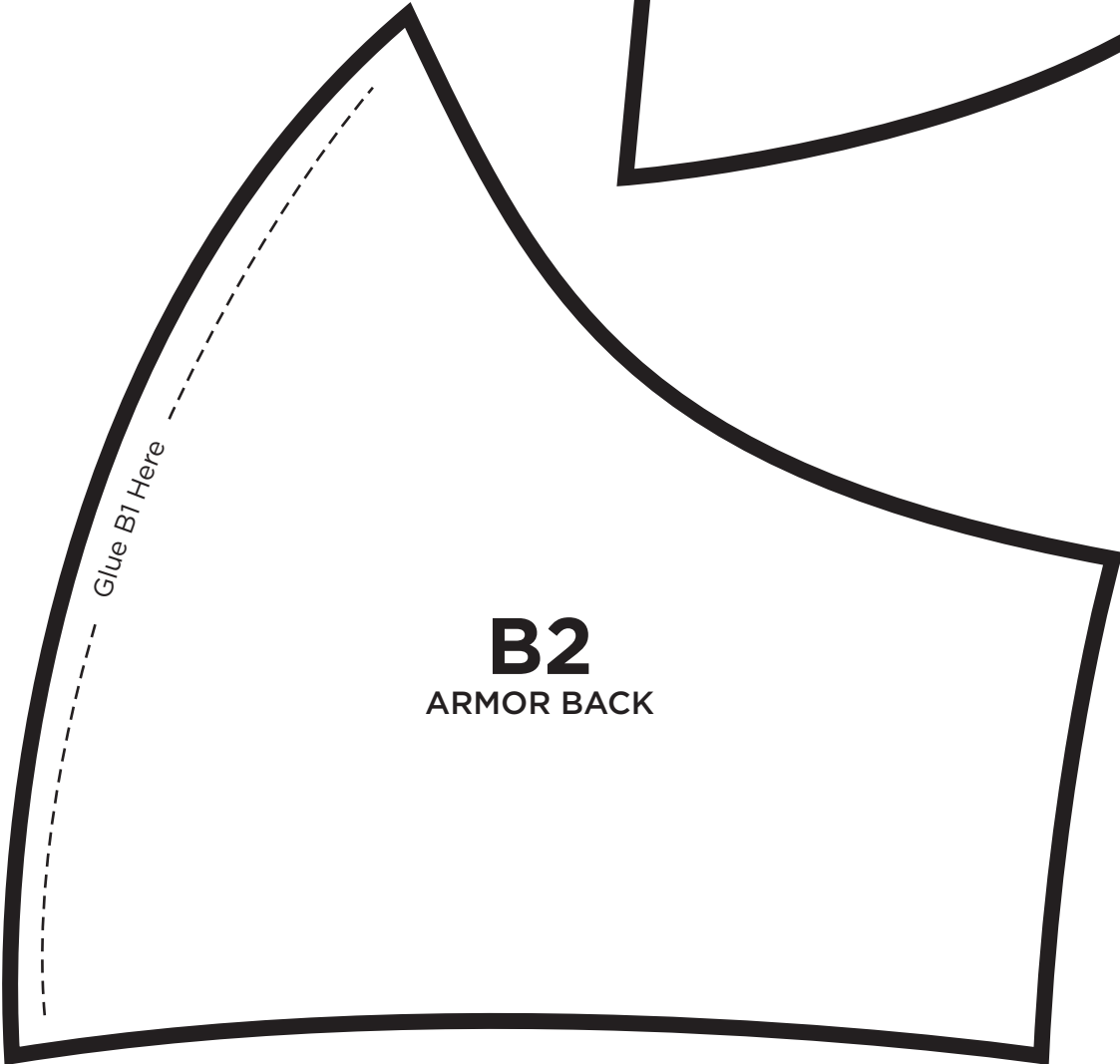
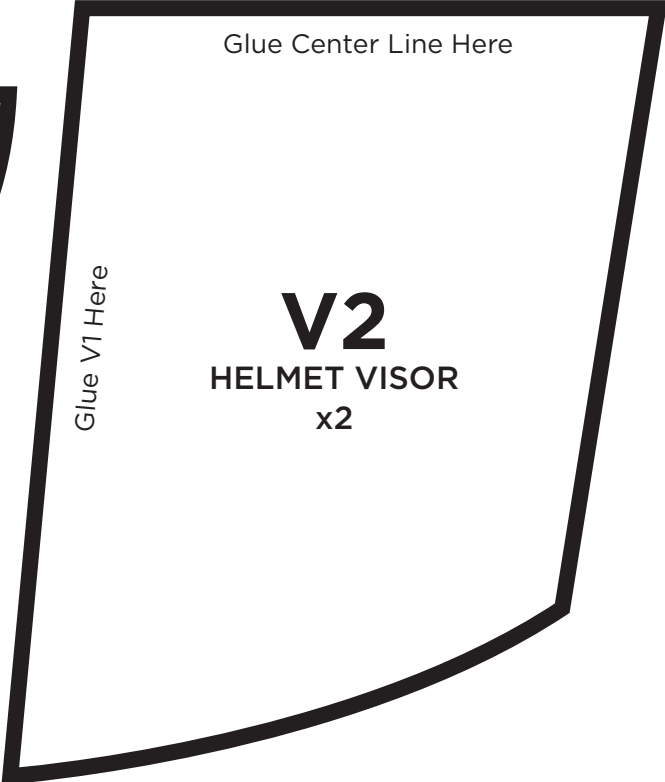
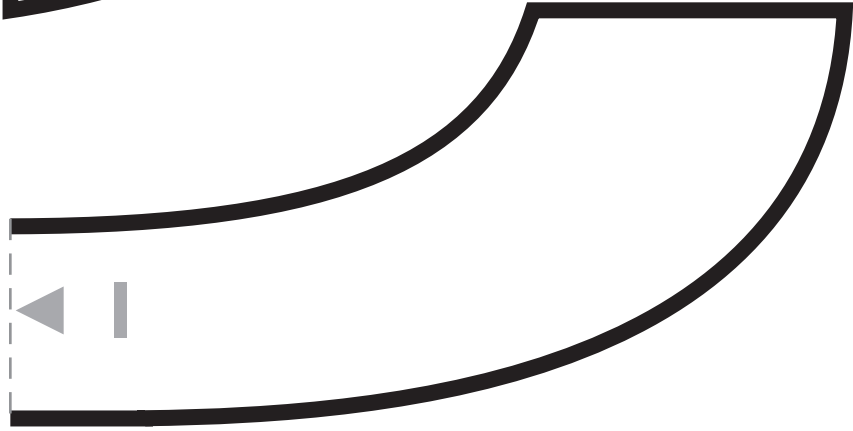
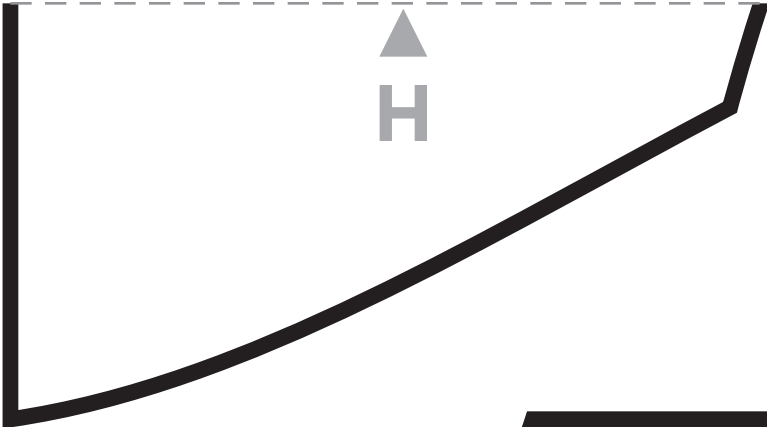

Knight Template I

See *Knight Template Guide* for instructions.

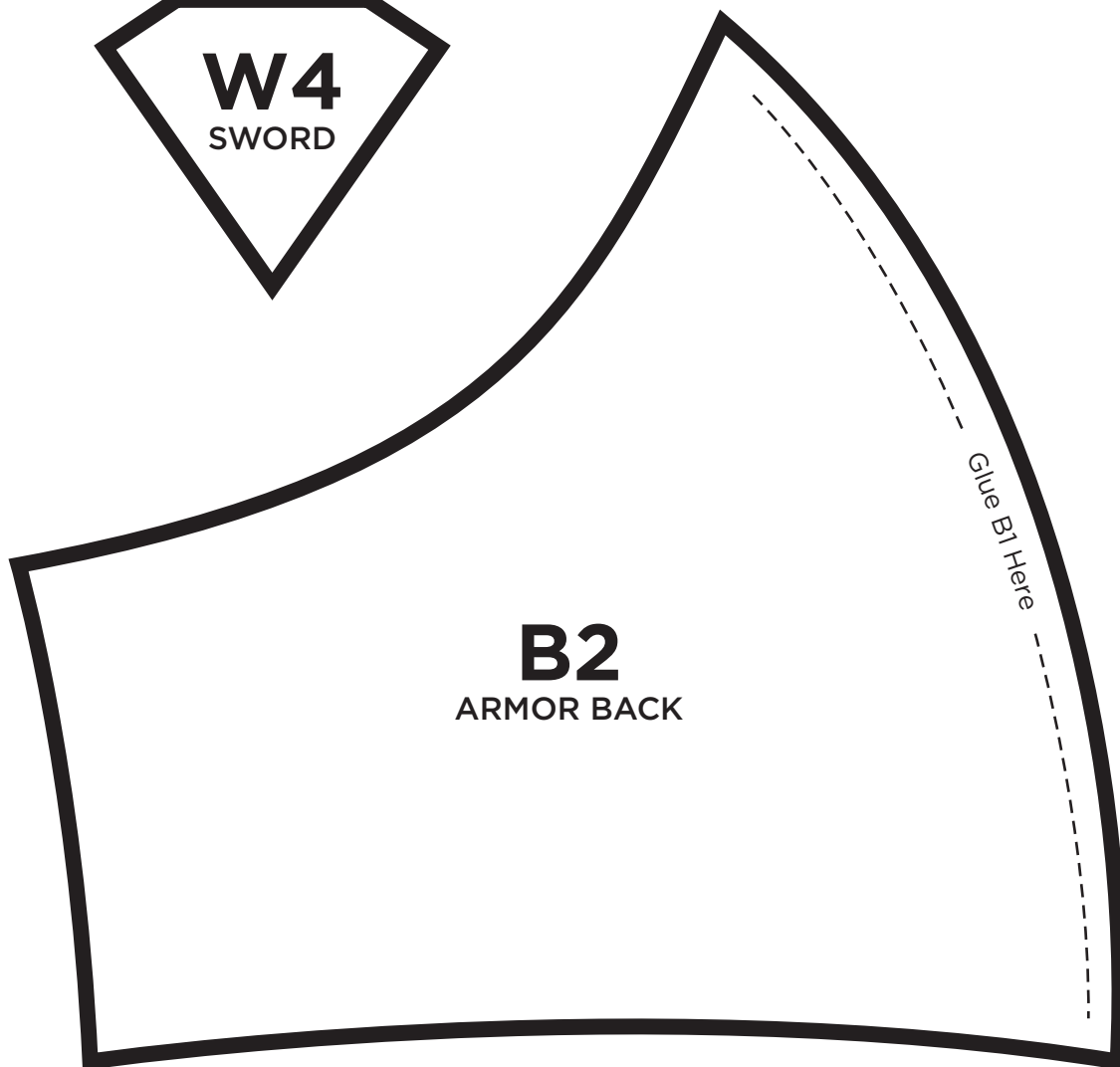
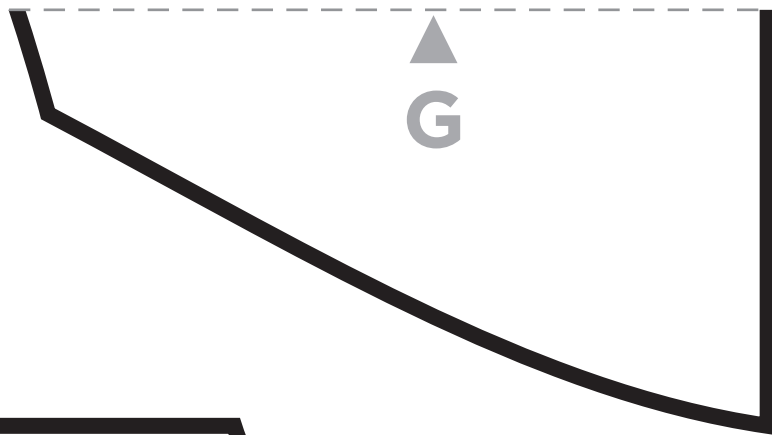

Knight Template J

See *Knight Template Guide* for instructions.

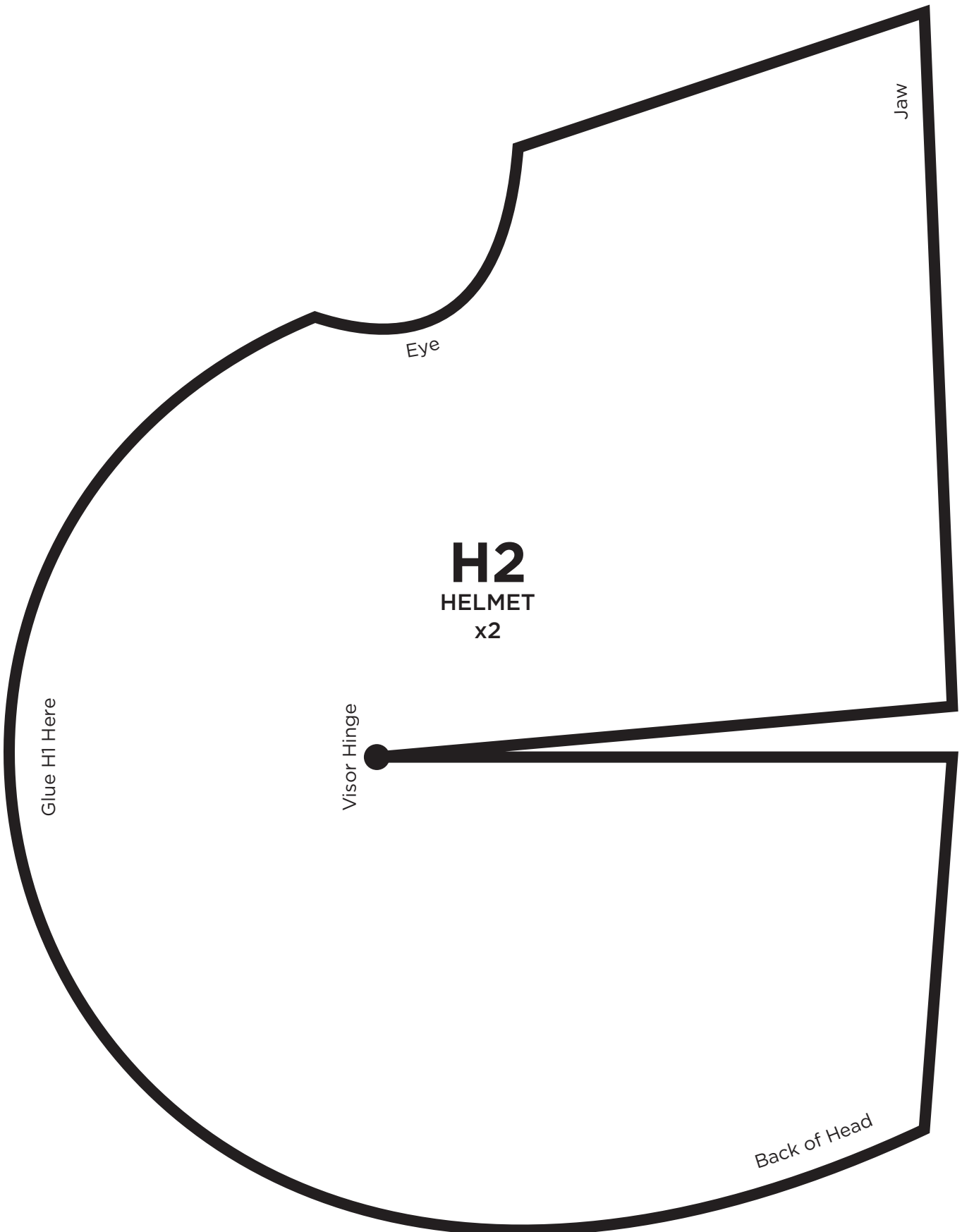

Knight Template 0

See *Knight Template Guide* for instructions.

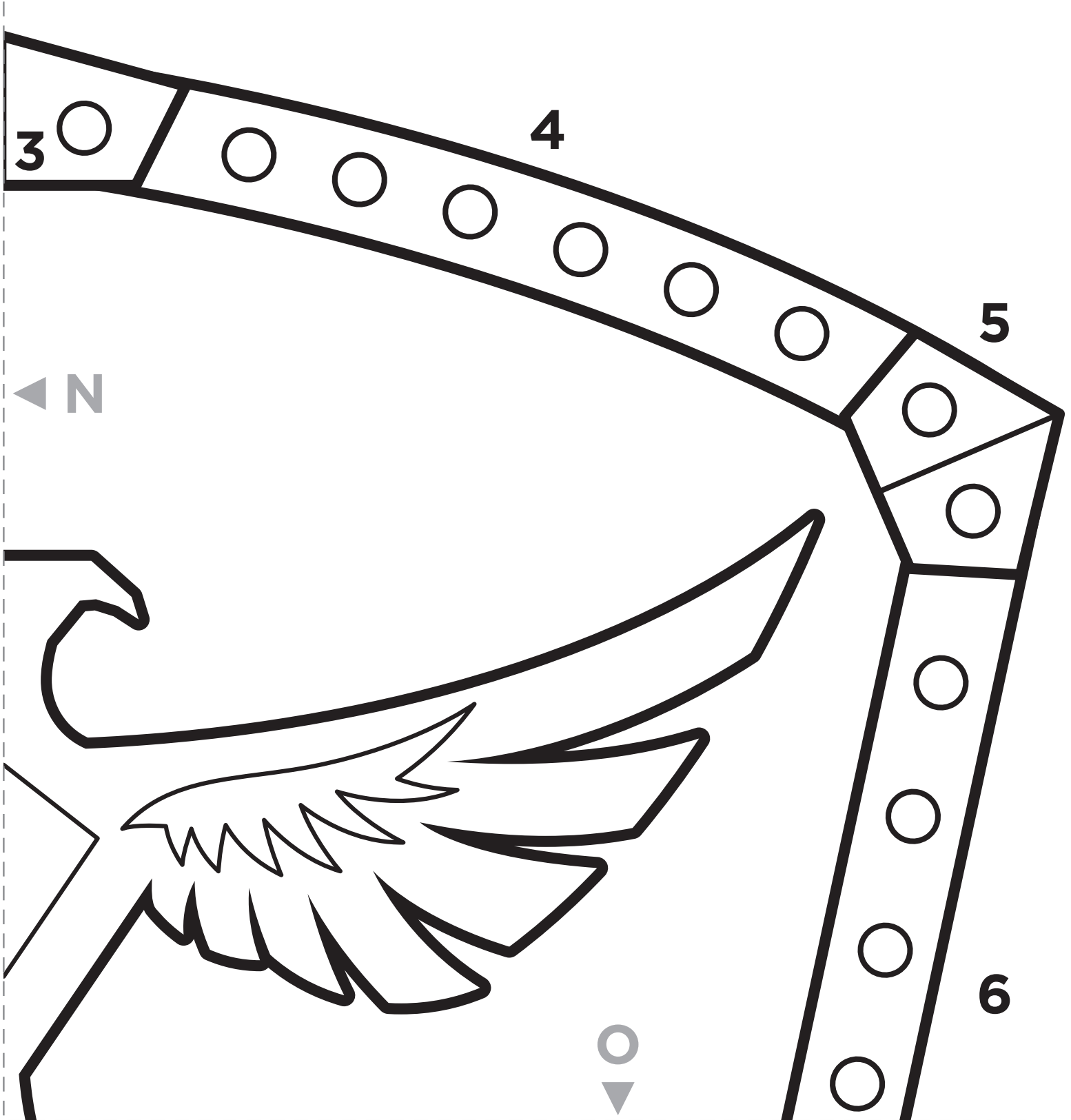

Knight Template P

See *Knight Template Guide* for instructions.

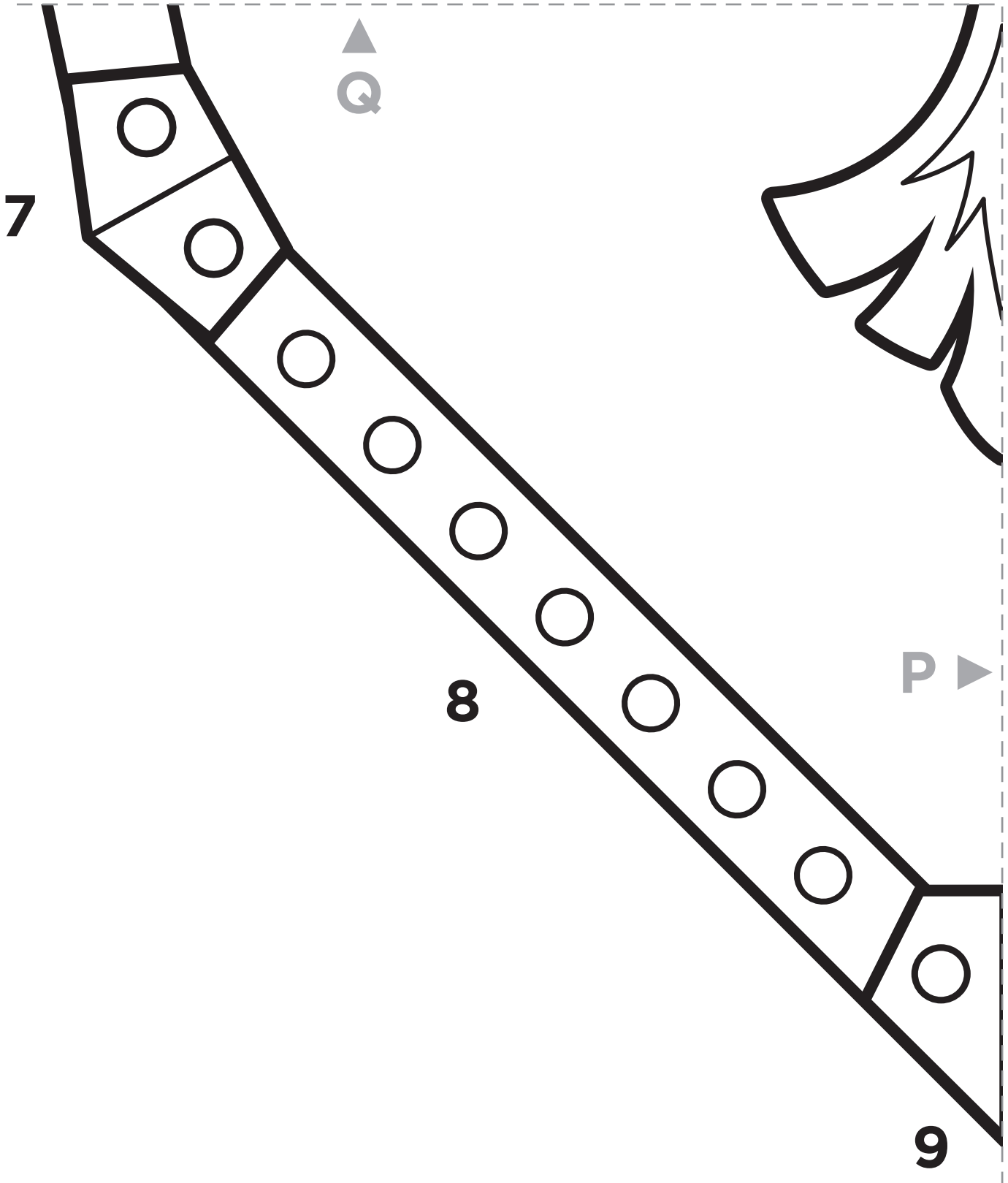

Knight Template Q

See *Knight Template Guide* for instructions.

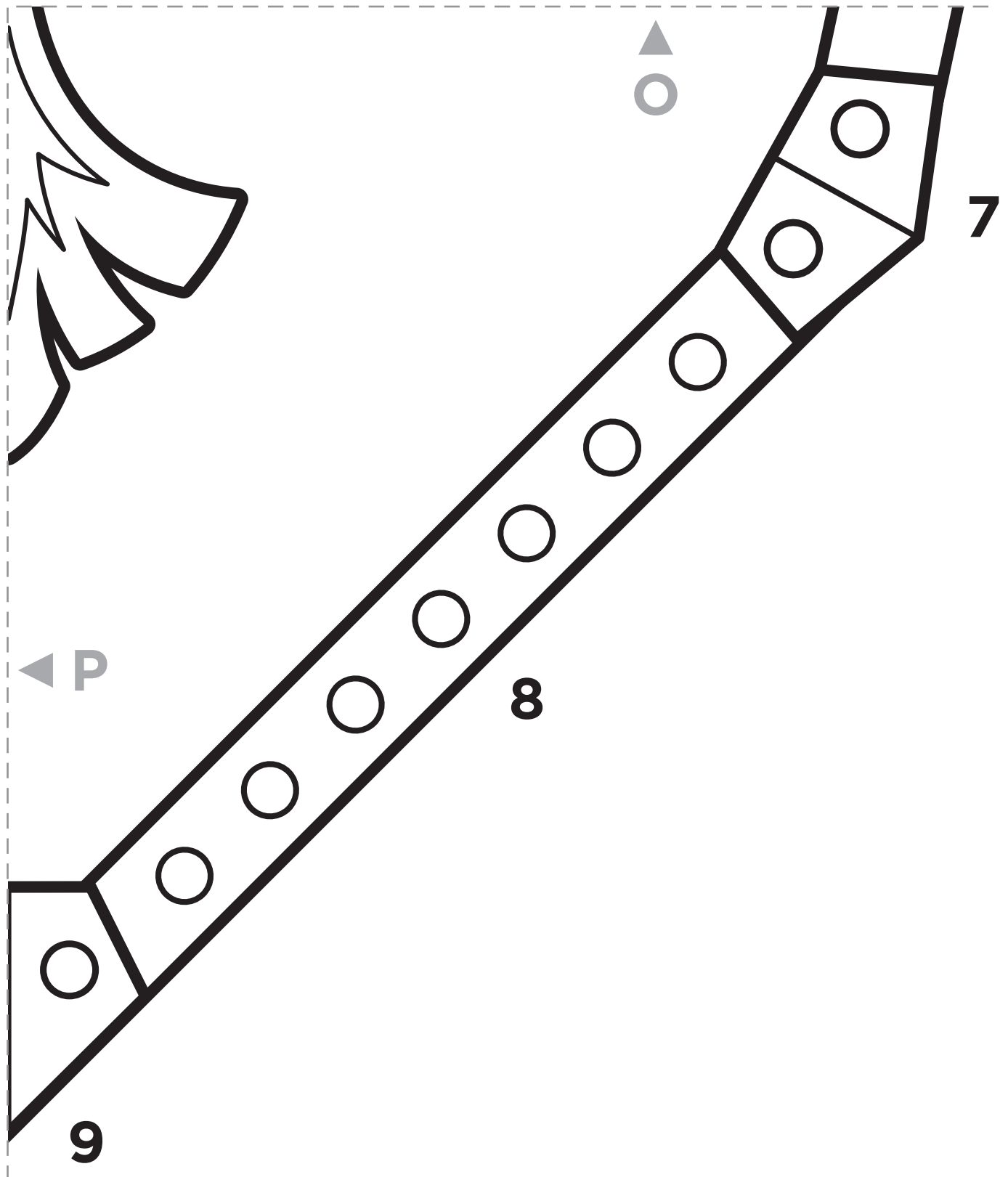



PIXIE PERFECTION

Bring a bit of whimsy and wonder to the costume party with a woodland fairy princess outfit!



SWEET FEET

First time making foam costumes? We recommend jumping in feet first...literally! Creating custom footwear is a great way to practice the basics—like shaping, texturing and more.



SUPER SUIT

Calling all future space travelers and superheroes—here's a high-tech, sci-fi inspired costume that's out-of-this-world!

Tip: Use hook-and-loop straps to make armor adjustable.



CROWN JEWEL

No princess is complete without her crown! Embellished with resin gemstones and foam clay accents, this headpiece truly is a crowning achievement.

Pixie Template Guide

- For a full size template, cut out all pieces.

Align arrow ends and tape template together.

- Size fits youth 8-10 years old.
- Scale to desired size.



Pixie Template A

See *Pixie Template Guide* for instructions.

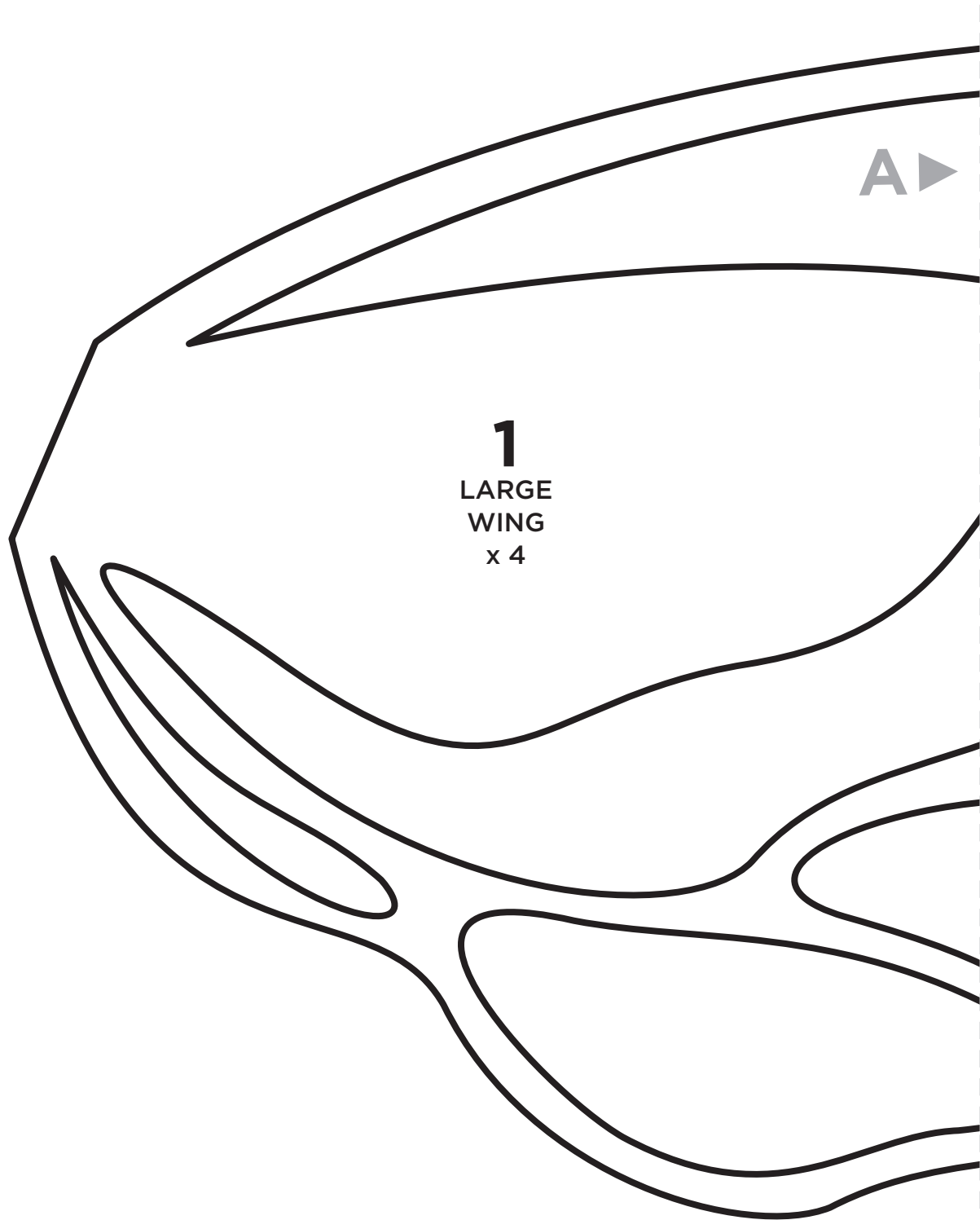

Pixie Template B

See *Pixie Template Guide* for instructions.

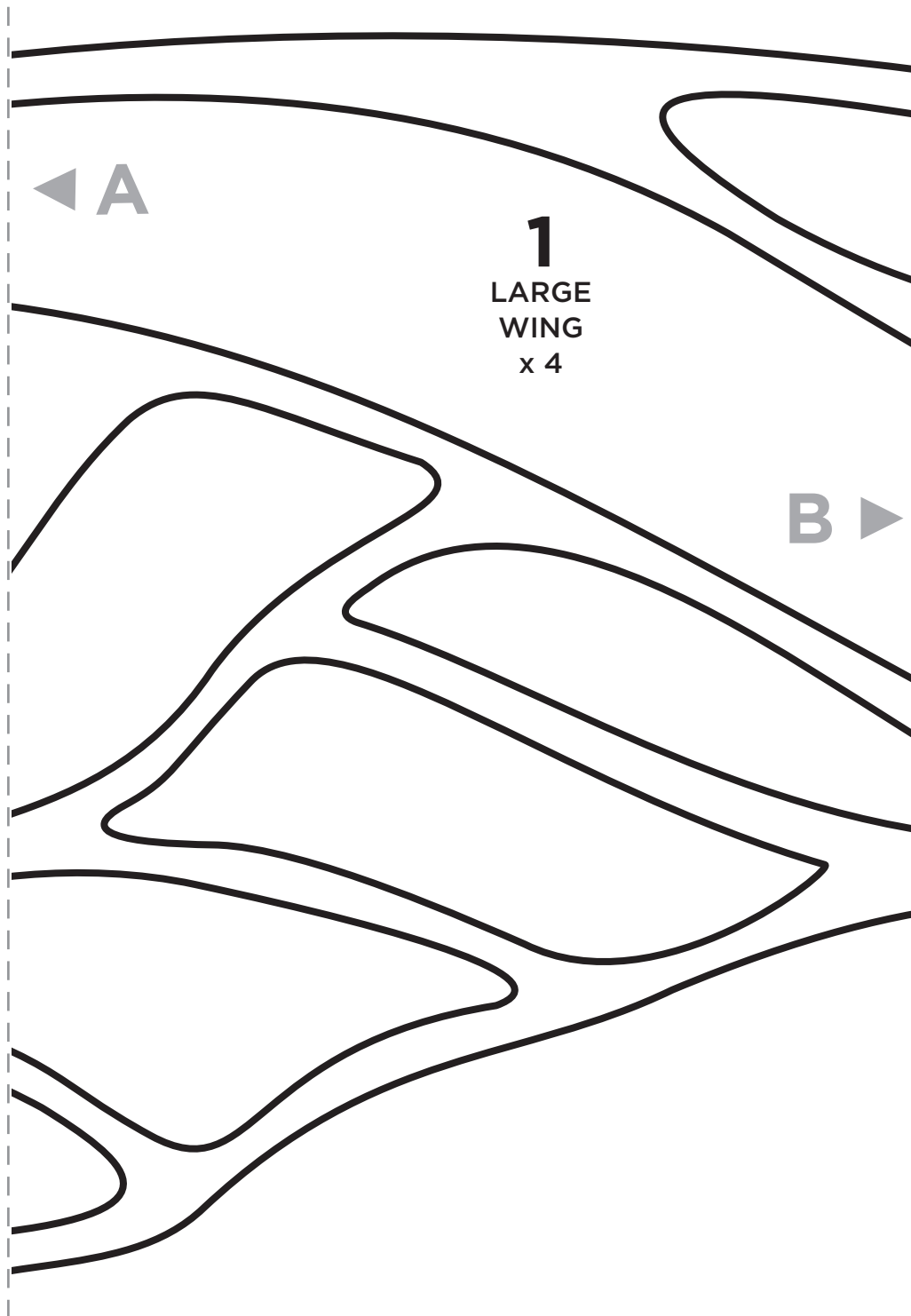

Pixie Template C

See *Pixie Template Guide* for instructions.

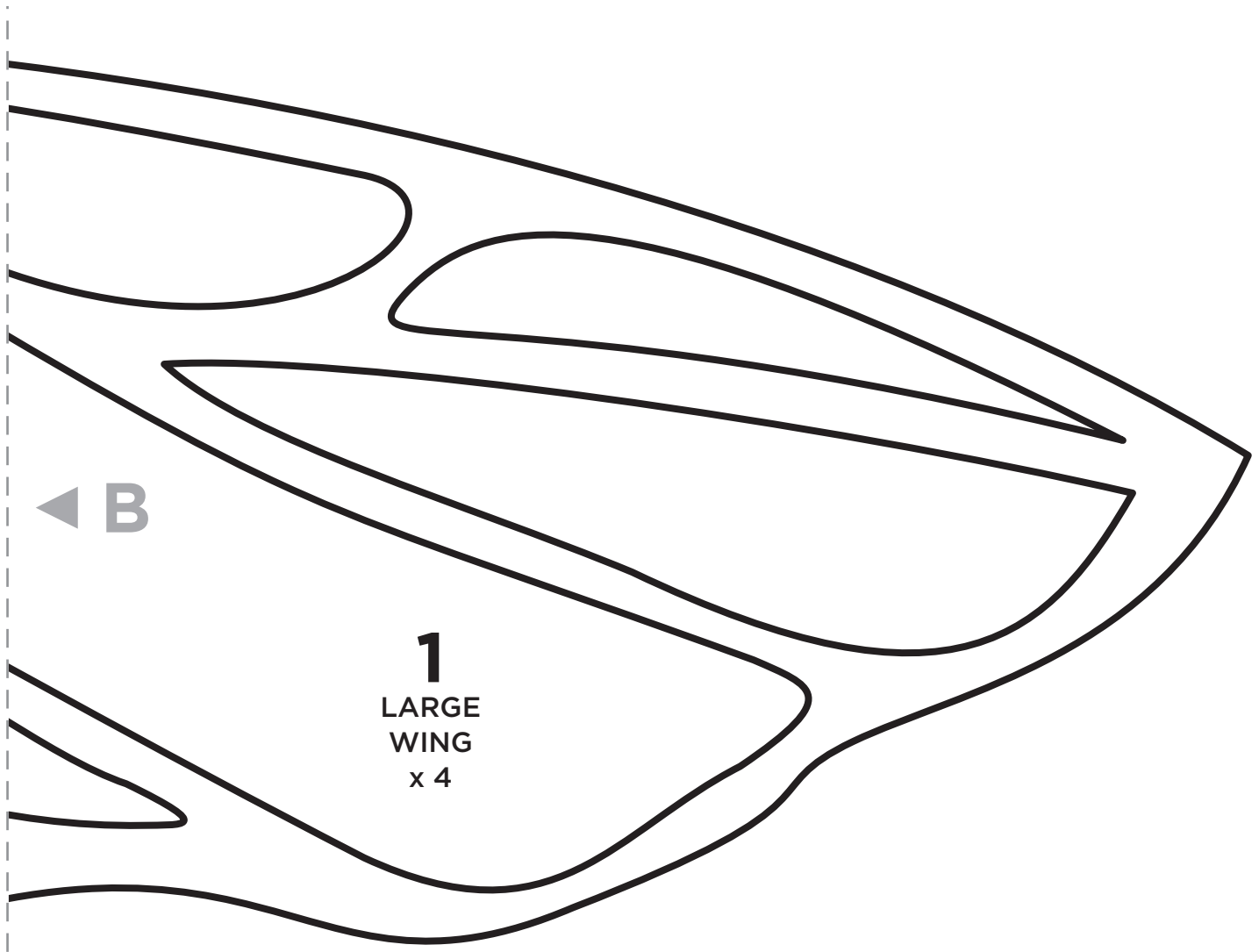

Pixie Template D

See *Pixie Template Guide* for instructions.

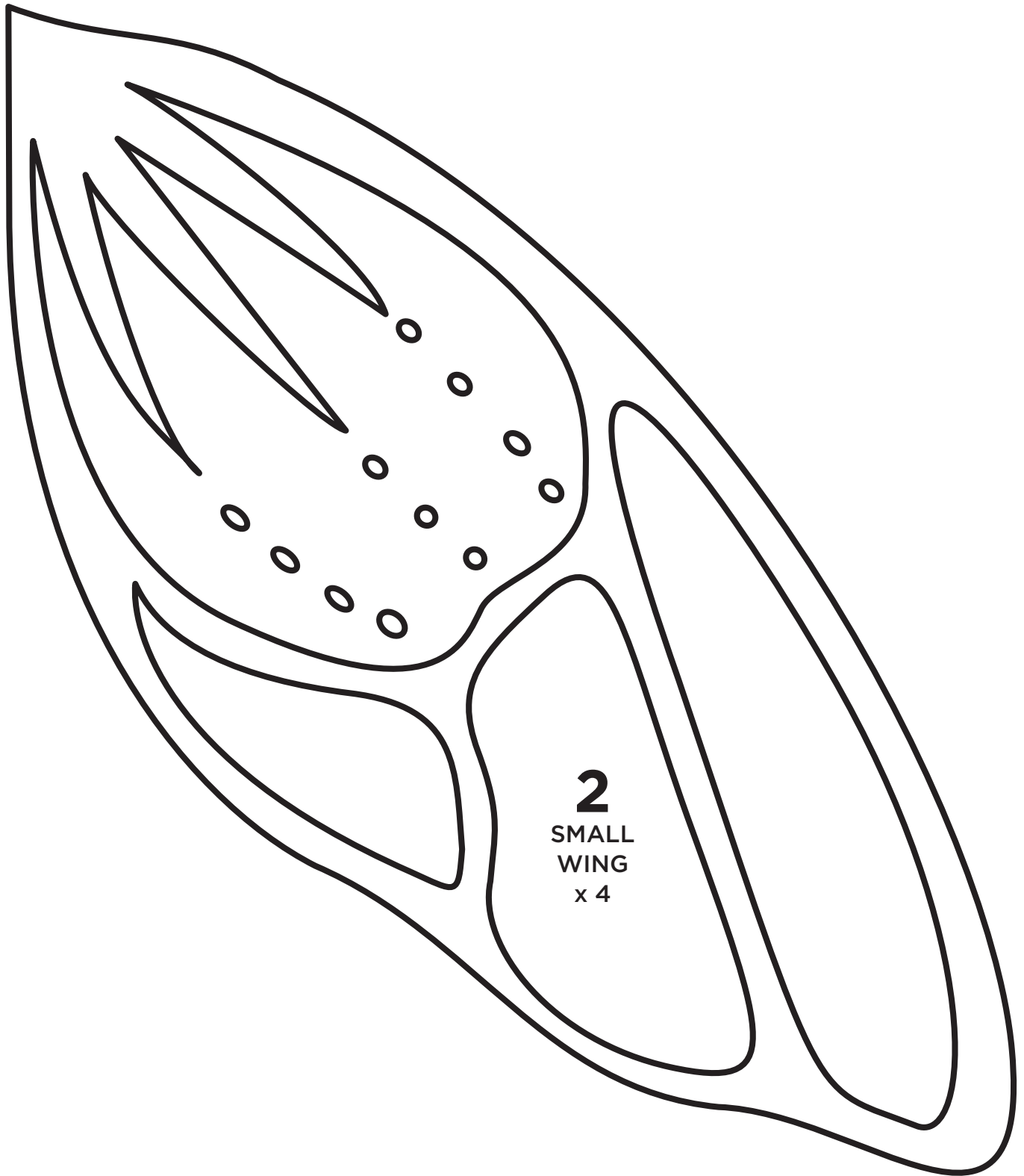

Pixie Template E

See *Pixie Template Guide* for instructions.

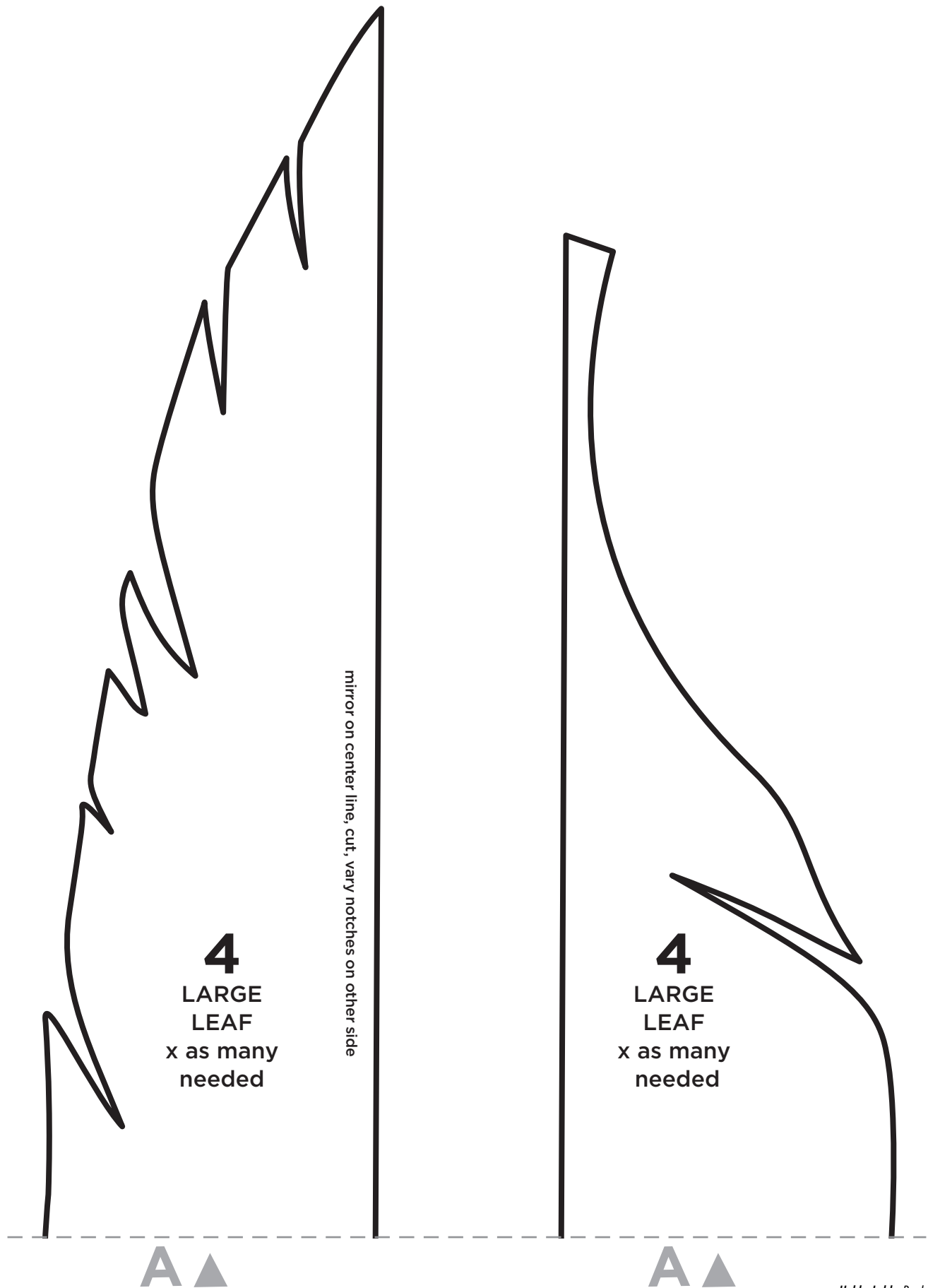

Pixie Template F

See *Pixie Template Guide* for instructions.



RIBBON TAB

3
SMALL
LEAF
x as many
needed

STONE SETTING

We used air-dry foam clay to create the faux metal castings around each resin gemstone.

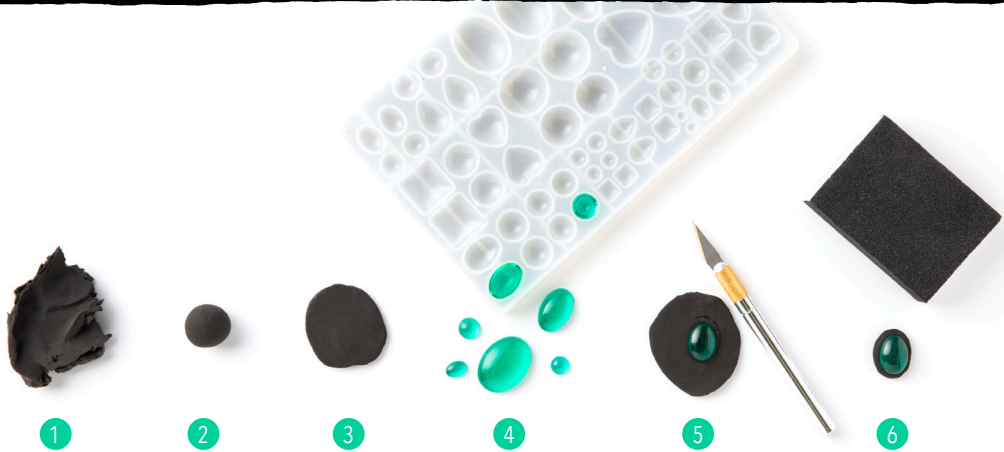

1. Air-dry foam clay.
2. Roll clay into ball.
3. Flatten with roller.
4. Remove cured resin gem from mold.
5. Lightly press gem into flattened clay. Use craft knife to cut edge around gem.

6. Let clay harden, then sand edges of gemstone casting until smooth. Adhere casting to foam crown with rubber cement (this adhesive only sticks to itself, so it must be applied to both the casting and the crown).

Headdress Template A

See *Headdress Template Guide* for instructions.

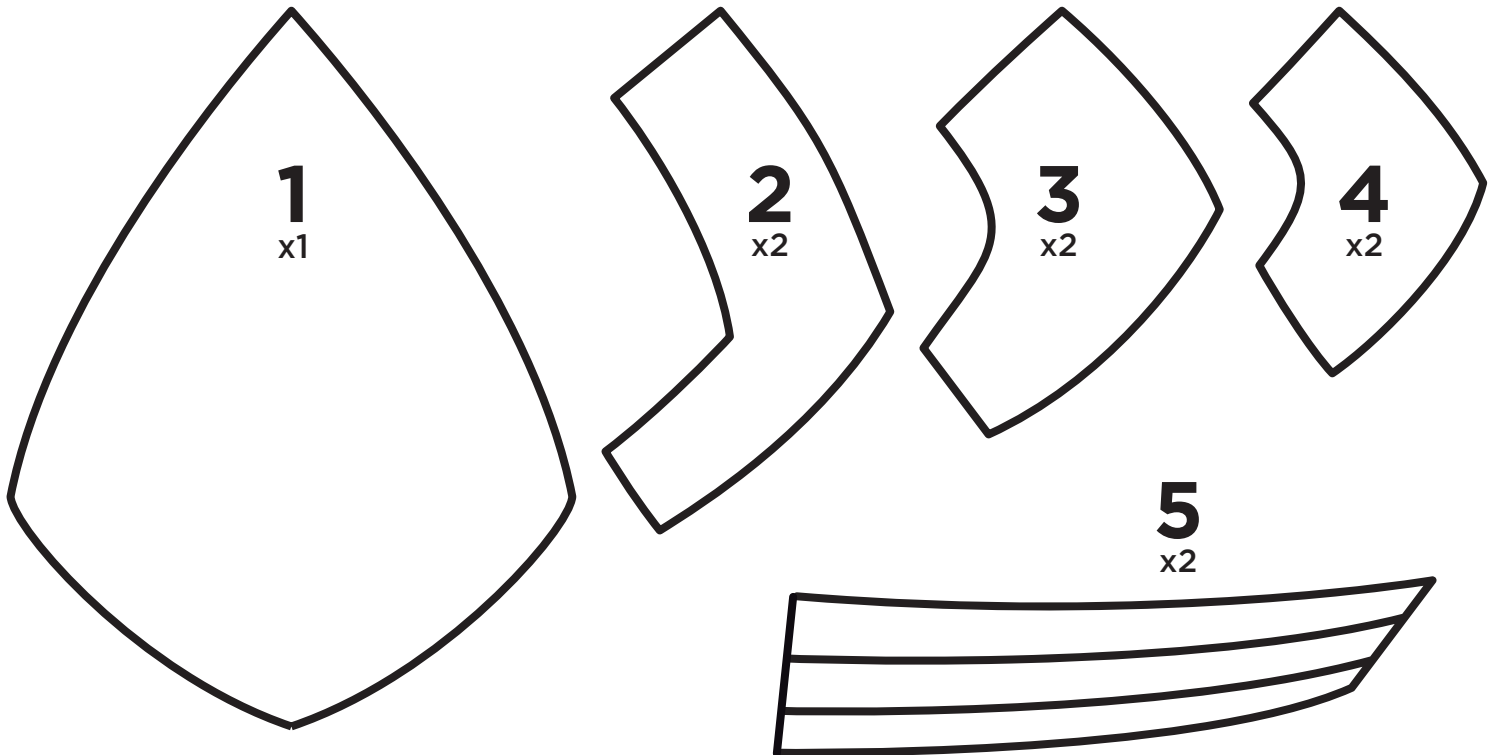
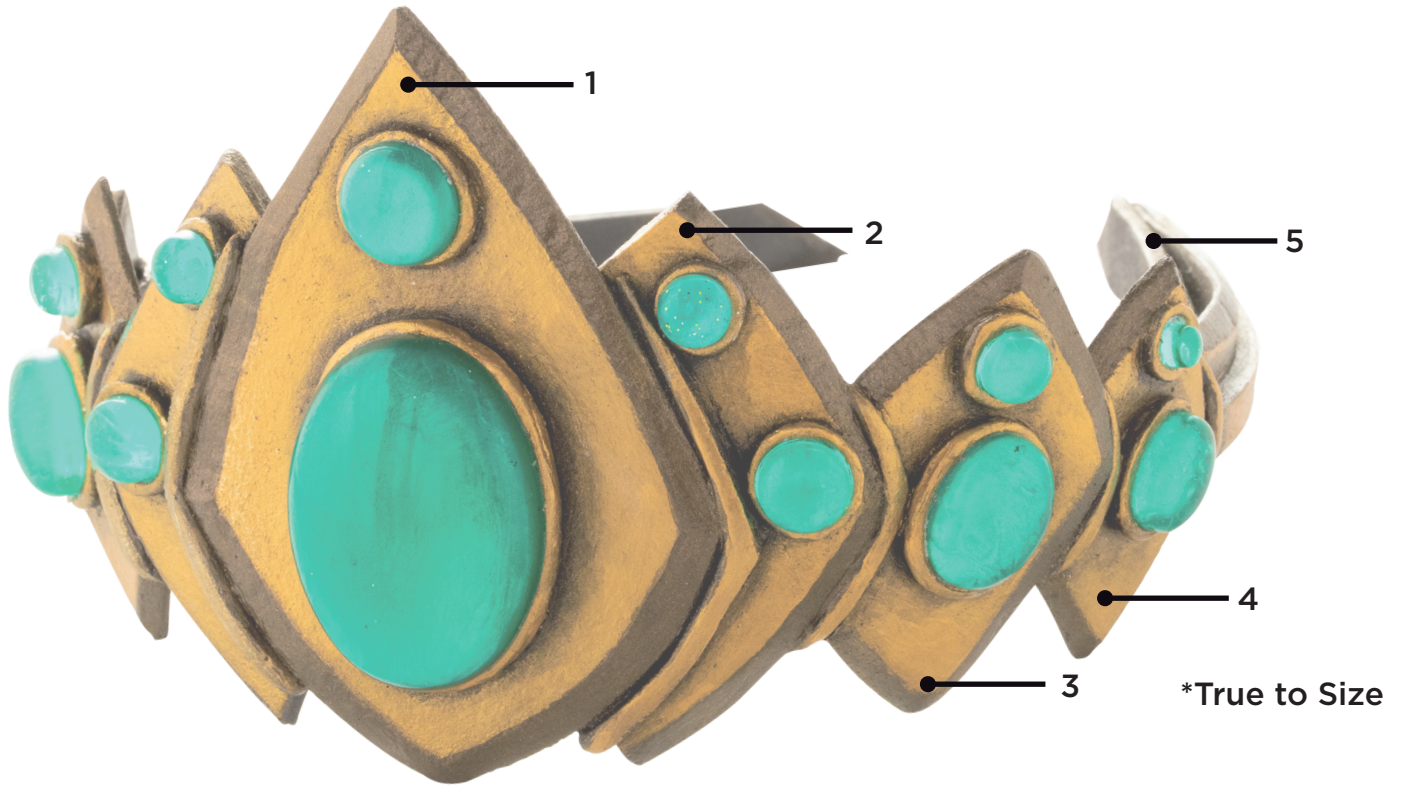



STEP 1

Cut shoulder pad pieces.

STEP 2

Apply rubber cement to foam pieces (this adhesive only sticks to itself, so it must be applied along both sections of foam).



STEP 3

Heat foam (with heat gun) while connecting and curving pieces into desired shape.



SHAPING

When foam is heated, it can be molded and manipulated into desired shapes—like these rounded shoulder pads. Heat also allows the foam to bend without cracking.

Sci Fi Armor Template Guide

- For a full size template, cut out all pieces.
- Align arrow ends and tape template together.
- Size fits youth 8-10 years old.
- Scale to desired size.

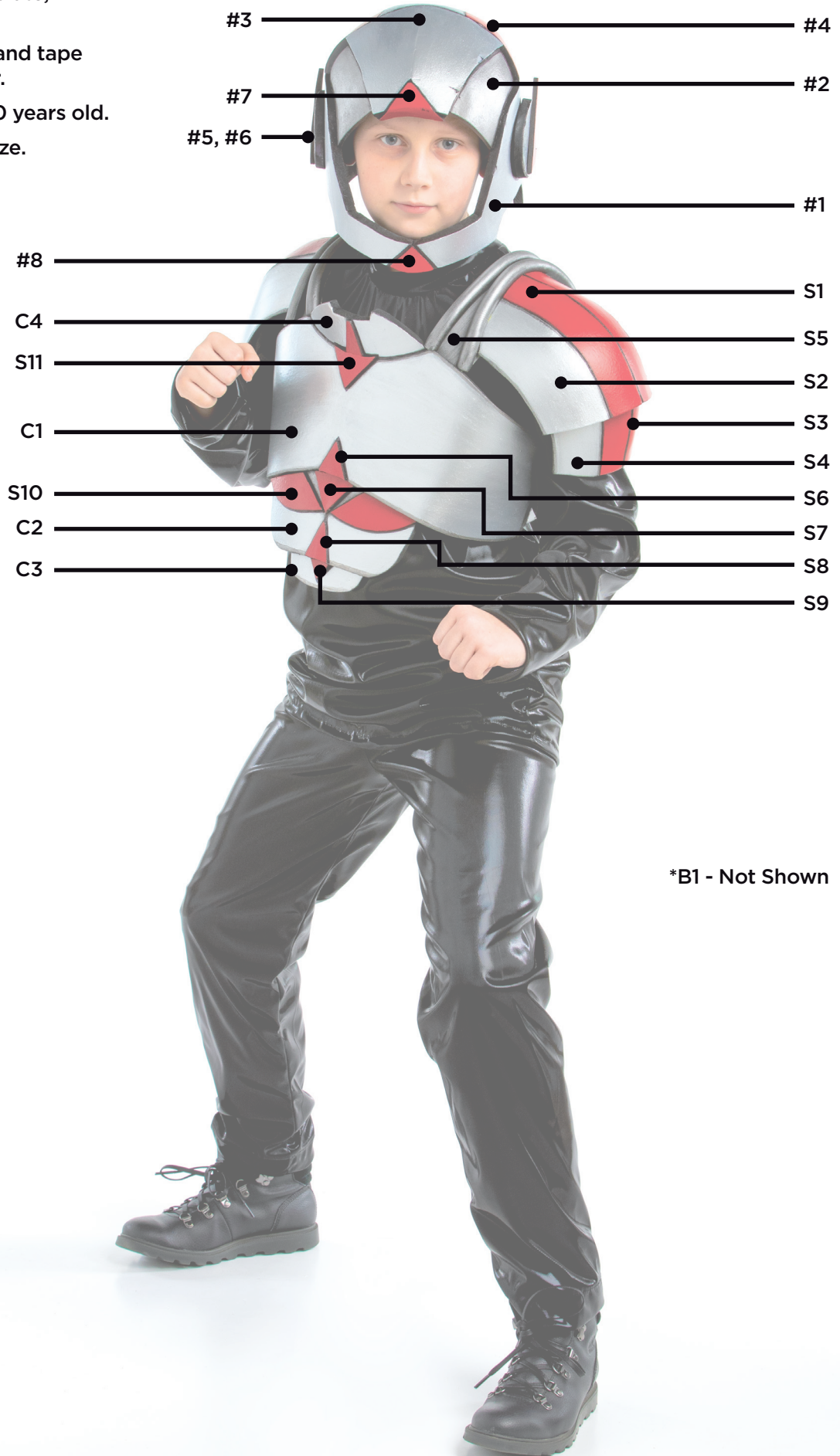

*B1 - Not Shown

Sci Fi Armor Template A

See *Sci Fi Armor Template Guide*
for instructions.

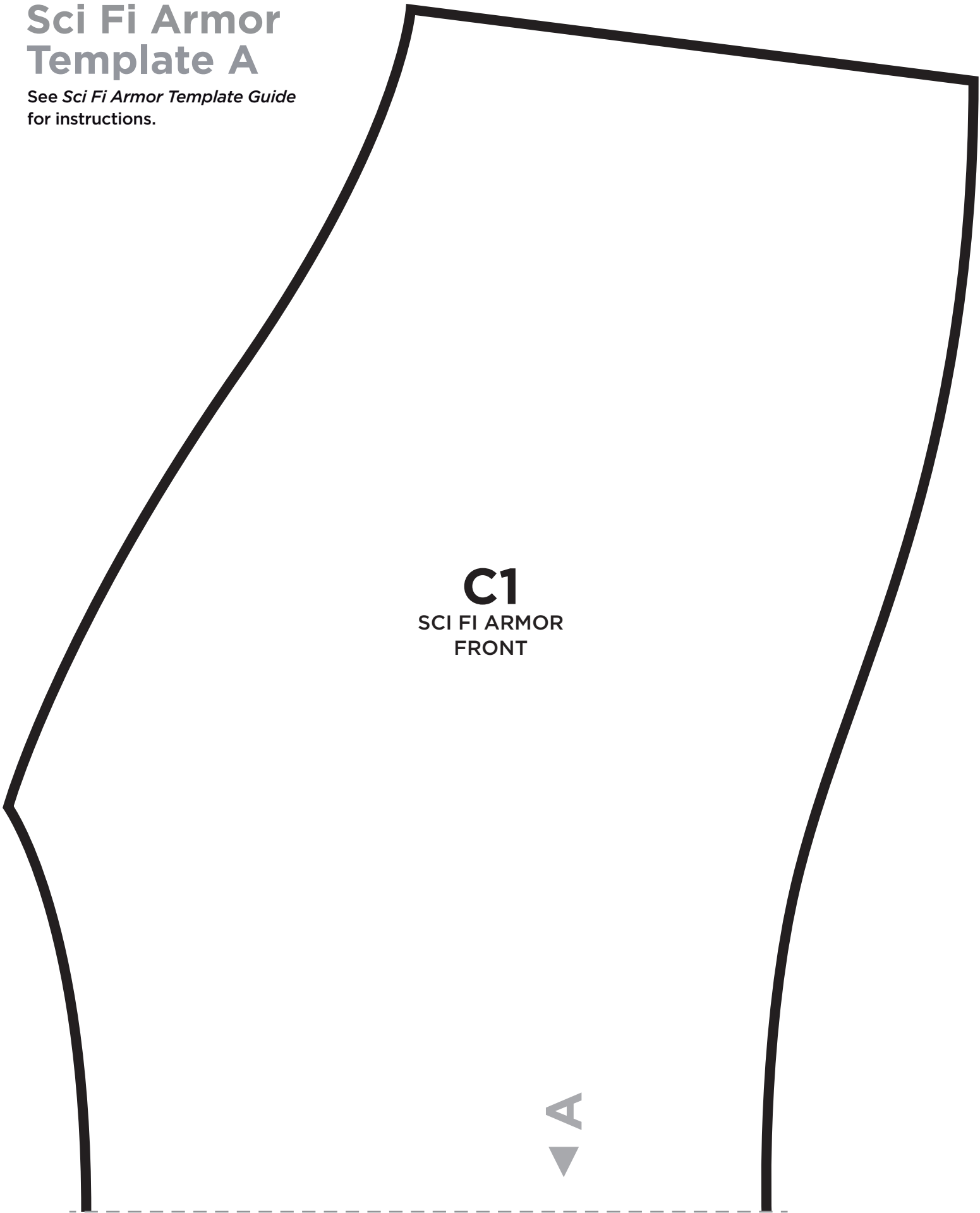

C1
SCI FI ARMOR
FRONT

▼ A

Sci Fi Armor Template B

See *Sci Fi Armor Template Guide*
for instructions.

C1
SCI FI ARMOR
FRONT

A
▼

Sci Fi Armor Template C

See *Sci Fi Armor Template Guide* for instructions.

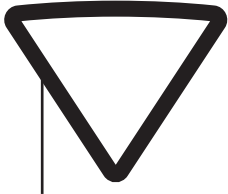

S9
ARMOR FRONT
DESIGN
X1

Extend as
needed based
on size of child



Glue here

S4
SCI FI SHOULDER
ARMOR
X2

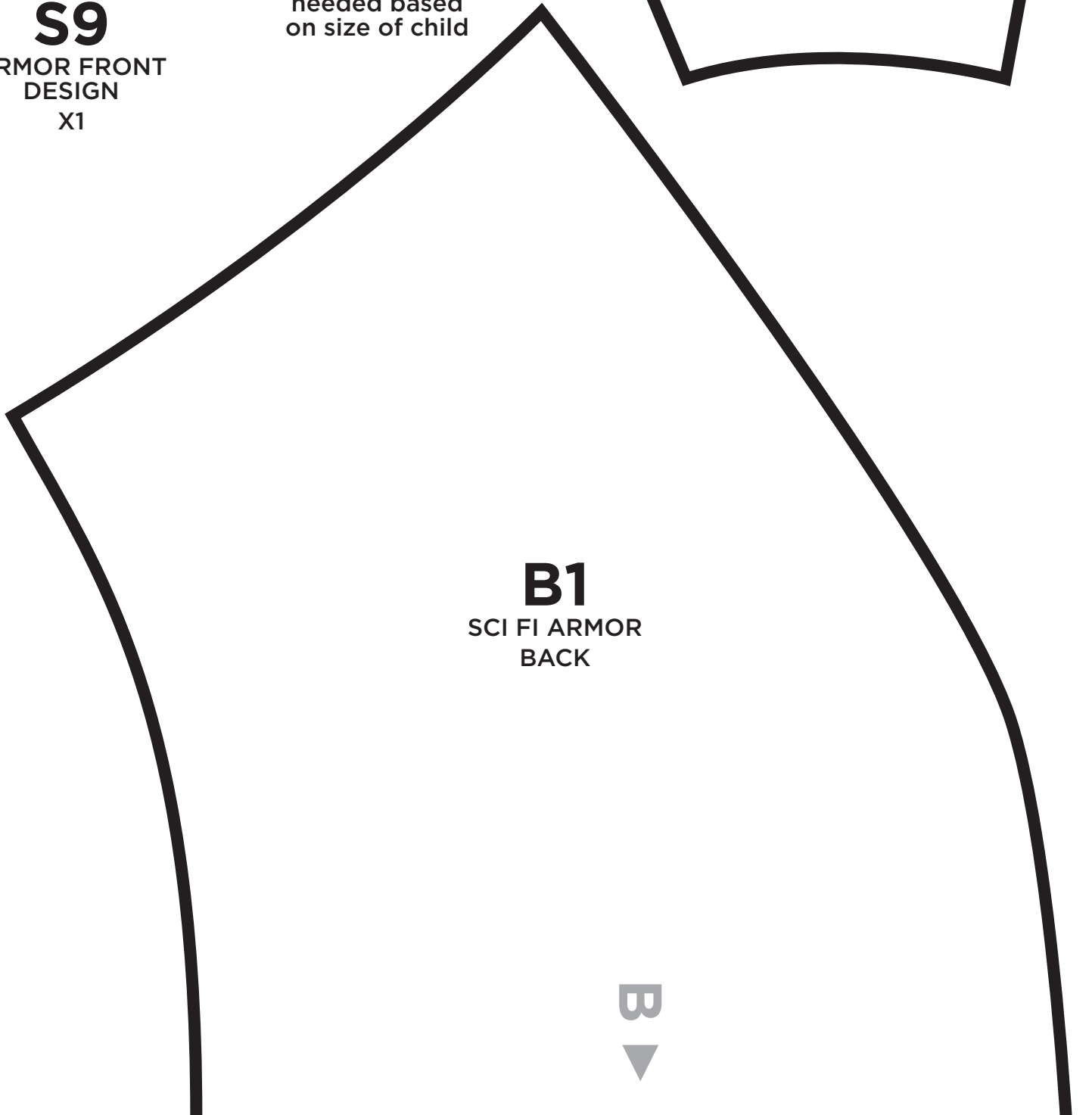

B1
SCI FI ARMOR
BACK



Sci Fi Armor Template D

See *Sci Fi Armor Template Guide* for instructions.

Glue here

S3

SCI FI SHOULDER ARMOR

X2



B1

SCI FI ARMOR

BACK

Extend as
needed based
on size of child

Sci Fi Armor Template E

See *Sci Fi Armor Template Guide* for instructions.

Glue here

S1

SCI FI SHOULDER ARMOR
X2

Glue here

S2

SCI FI SHOULDER ARMOR
X2

C3

SCI FI ARMOR
FRONT

Sci Fi Armor Template F

See *Sci Fi Armor Template Guide* for instructions.

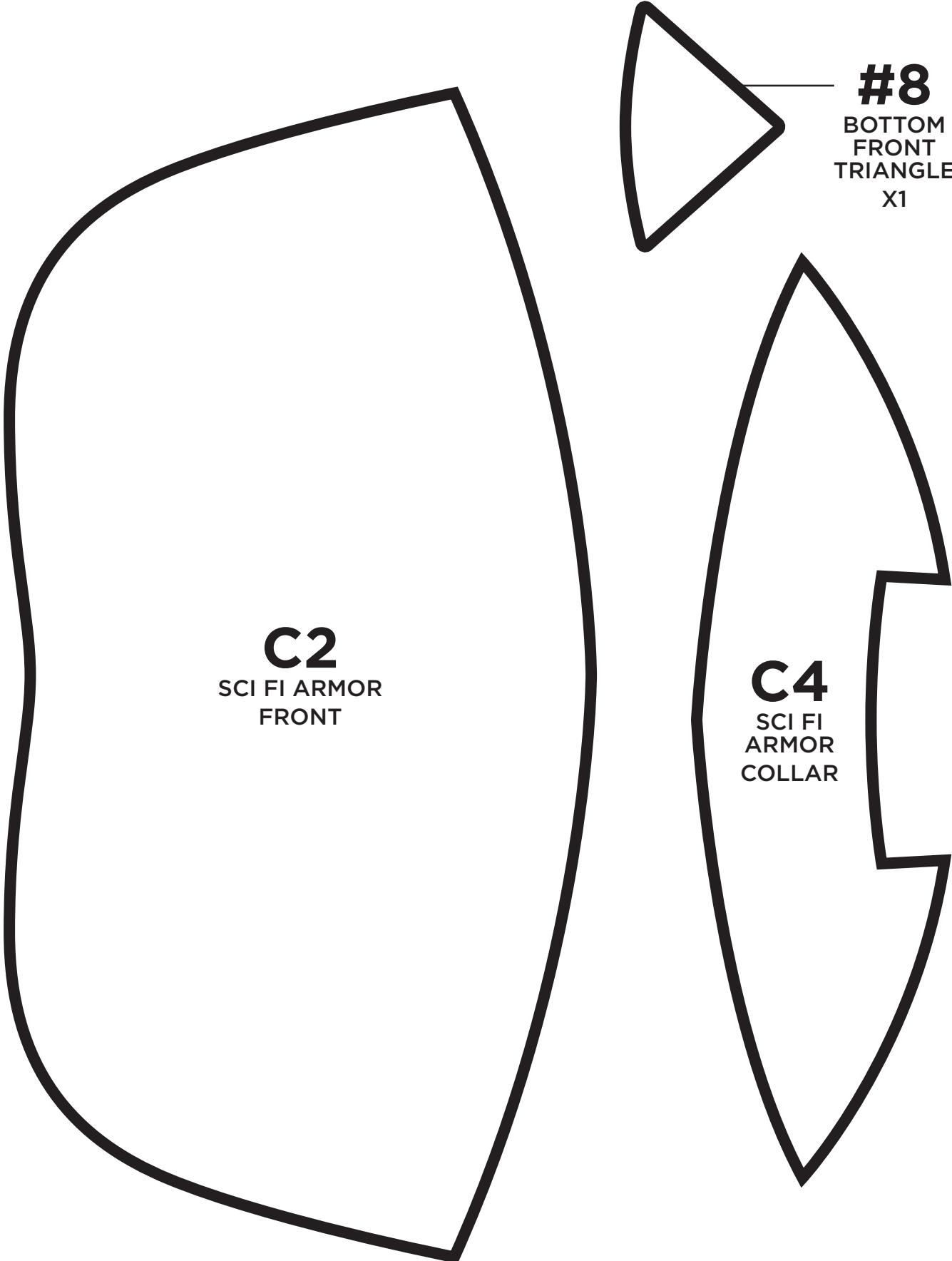

C2
SCI FI ARMOR
FRONT

C4
SCI FI
ARMOR
COLLAR

#8
BOTTOM
FRONT
TRIANGLE
X1

Sci Fi Armor Template G

See *Sci Fi Armor Template Guide* for instructions.

S6
ARMOR FRONT
DESIGN
X1

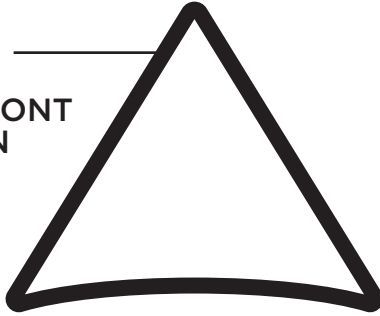

S10
ARMOR FRONT
DESIGN
X2



S7
ARMOR FRONT
DESIGN
X1



S11
ARMOR NECK
DESIGN
X1

S5
SCI FI ARMOR
SHOULDER STRAP
X2



Sci Fi Armor Template H

See *Sci Fi Armor Template Guide* for instructions.

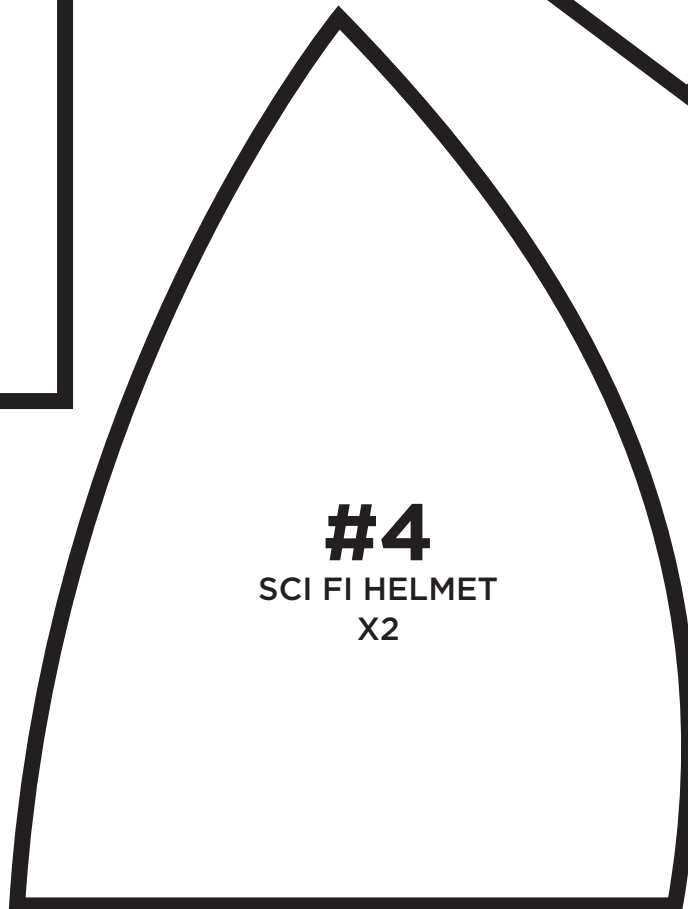
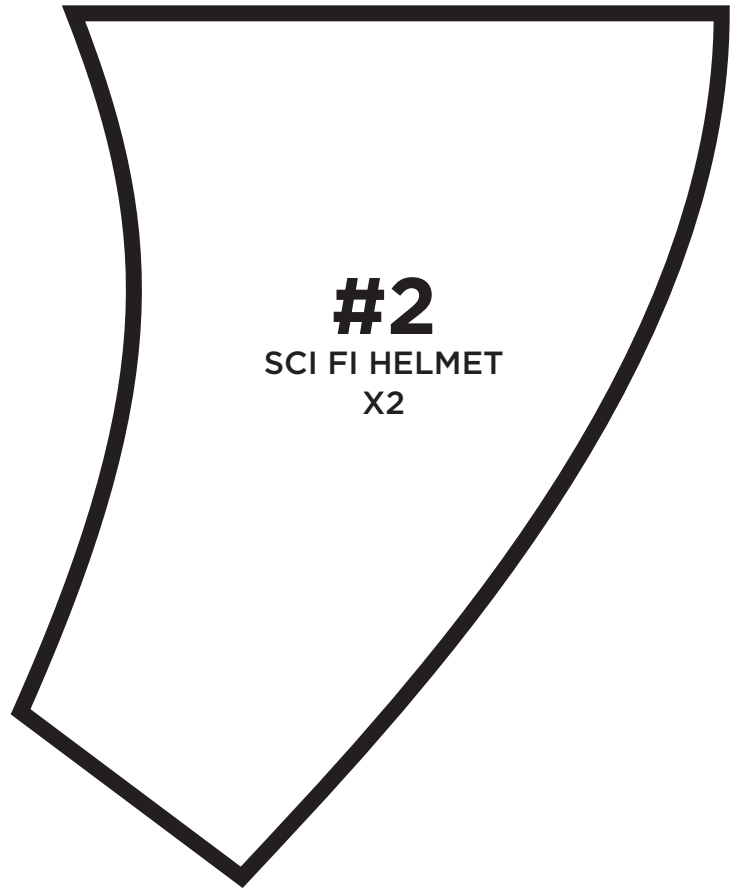
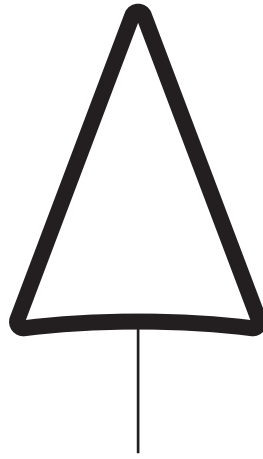

Sci Fi Armor Template I

See *Sci Fi Armor Template Guide* for instructions.

Wrap Around

#1
SCI FI HELMET
X1

F ▶

Close Gap

▼ G

#7
TOP FRONT
TRIANGLE
X1

Sci Fi Armor Template J

See *Sci Fi Armor Template Guide* for instructions.

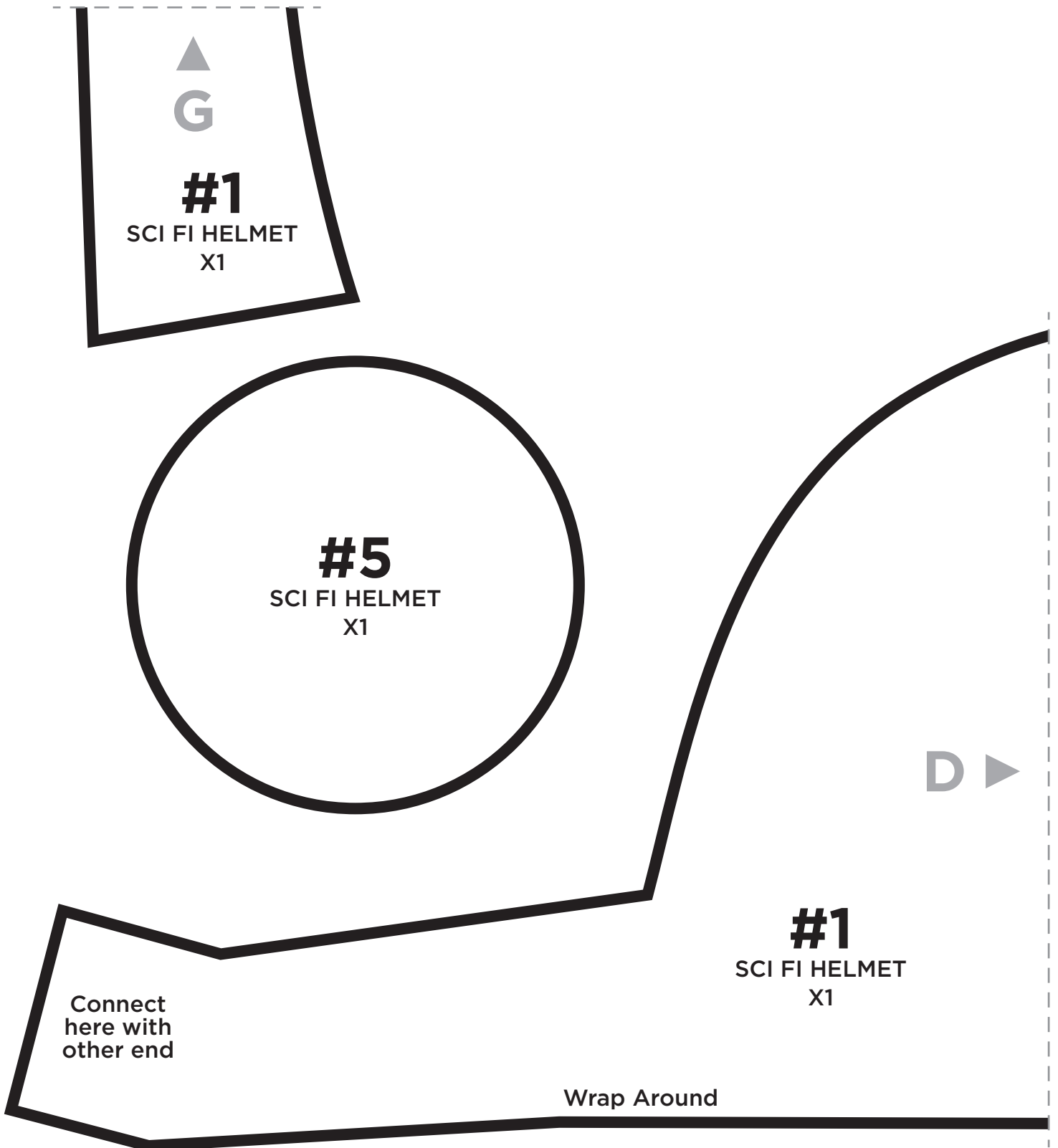

Sci Fi Armor Template K

See *Sci Fi Armor Template Guide* for instructions.

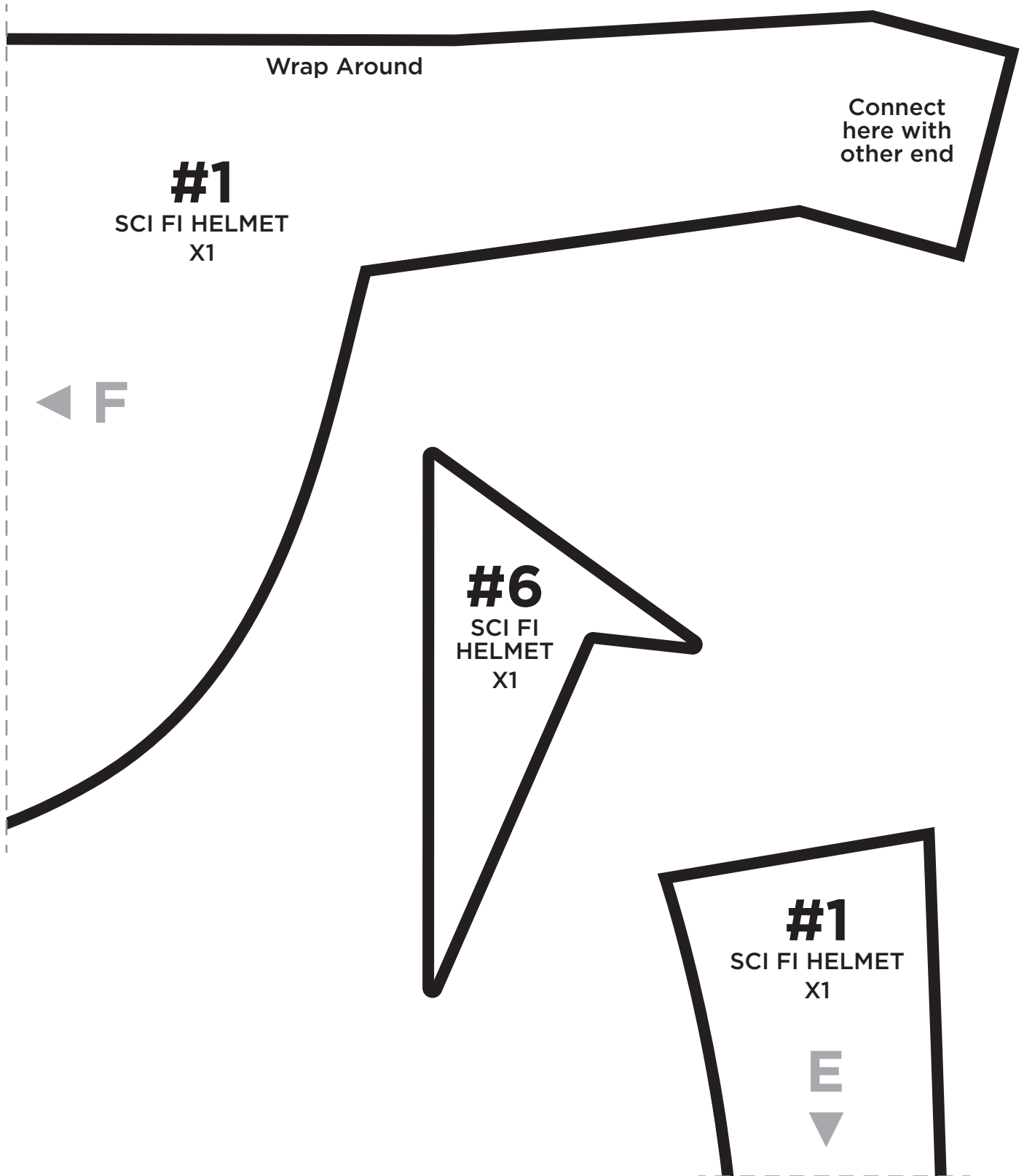

Sci Fi Armor Template L

See *Sci Fi Armor Template Guide* for instructions.

#3
SCI FI HELMET
X2



Close Gap



#1
SCI FI HELMET
X1

Wrap Around

TEXTURING

Add an extra level of detail to foam projects by creating textures. Use a rotary tool for deep, intricate features or a heated foil ball for minor impressions.



We textured our chicken feet with a crinkled ball of tin foil. Just warm the foil with a heat gun, then press it into the foam to form shallow imprints.



The quickest way to create rocky, reptile skin (like we've done here) is with a rotary tool. It easily carves into foam, forming deep texture that's full of dimension.



Lightly trace desired design onto foam with a pencil. Then carve the design with a rotary tool. Find rotary tool kits (with dozens of accessories) here in the Crafts Department.

We created the mermaid scale pattern with a craft knife, being careful not to cut all the way through the foam. The fins and earpieces were textured with clay shaping tools.

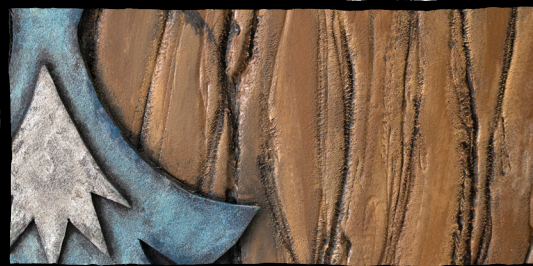

Create this wood-like texture by carving long vertical lines with a rotary tool. Apply various amounts of pressure as you go to form different sizes and depths of wood grain.

Creature Feet Template Guide

- For a full size template, cut out all pieces.
- Align arrow ends and tape template together.
- Size fits youth 8-10 years old.
- Scale to desired size.

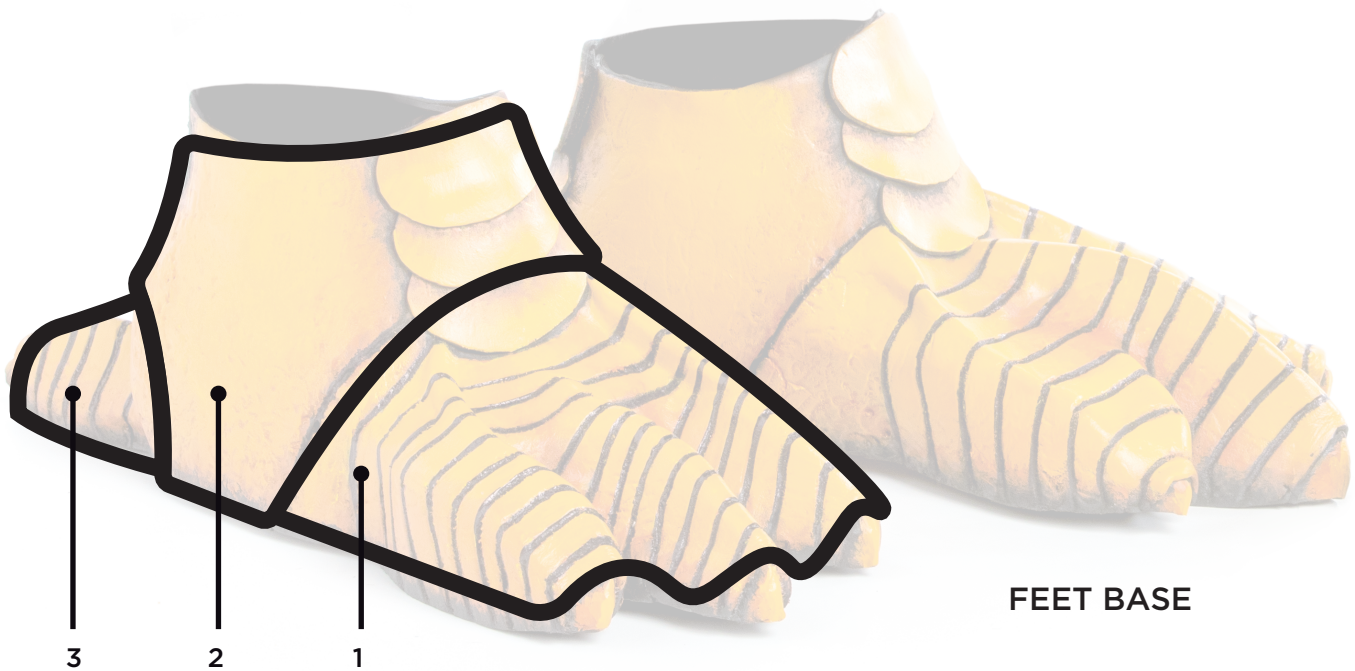

FEET BASE

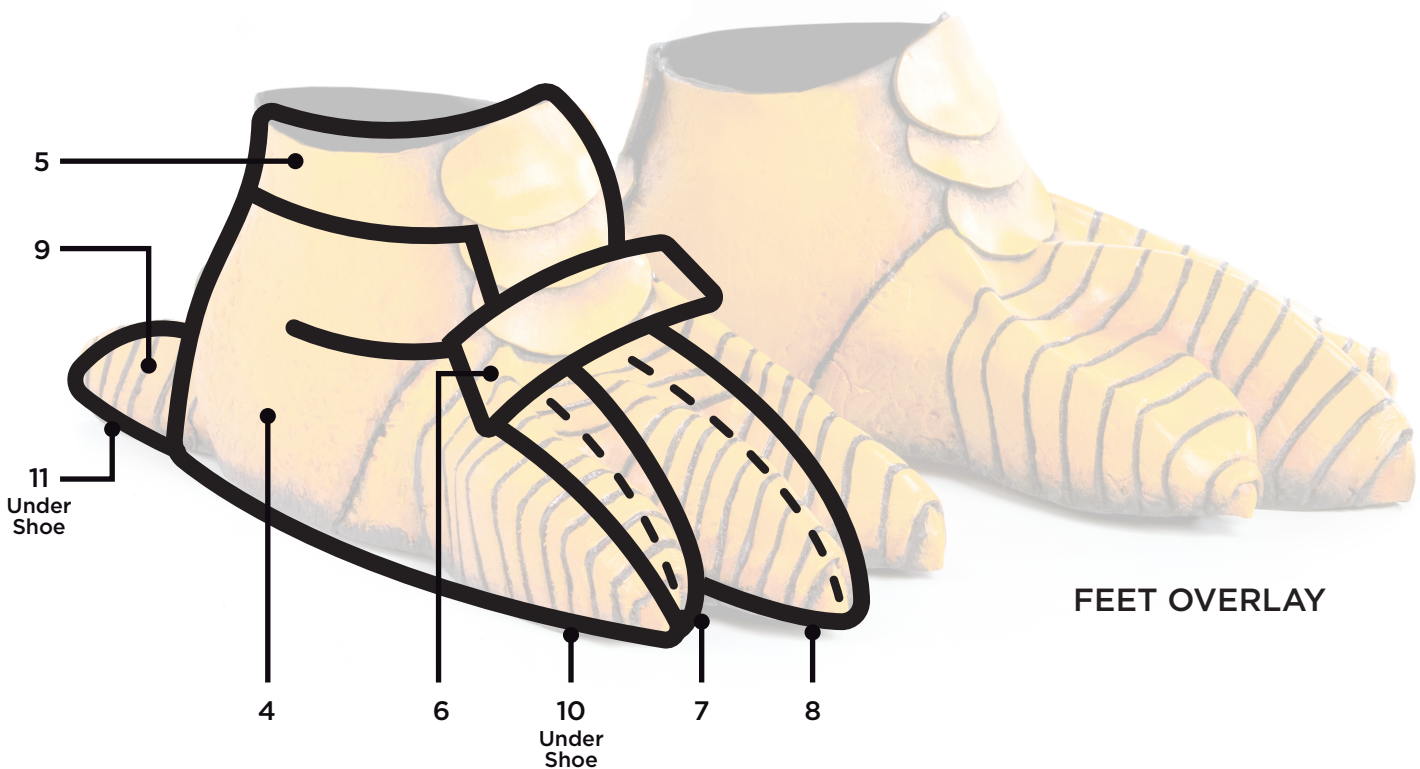

FEET OVERLAY

Creature Feet Template A

See *Creature Feet Template Guide* for instructions.

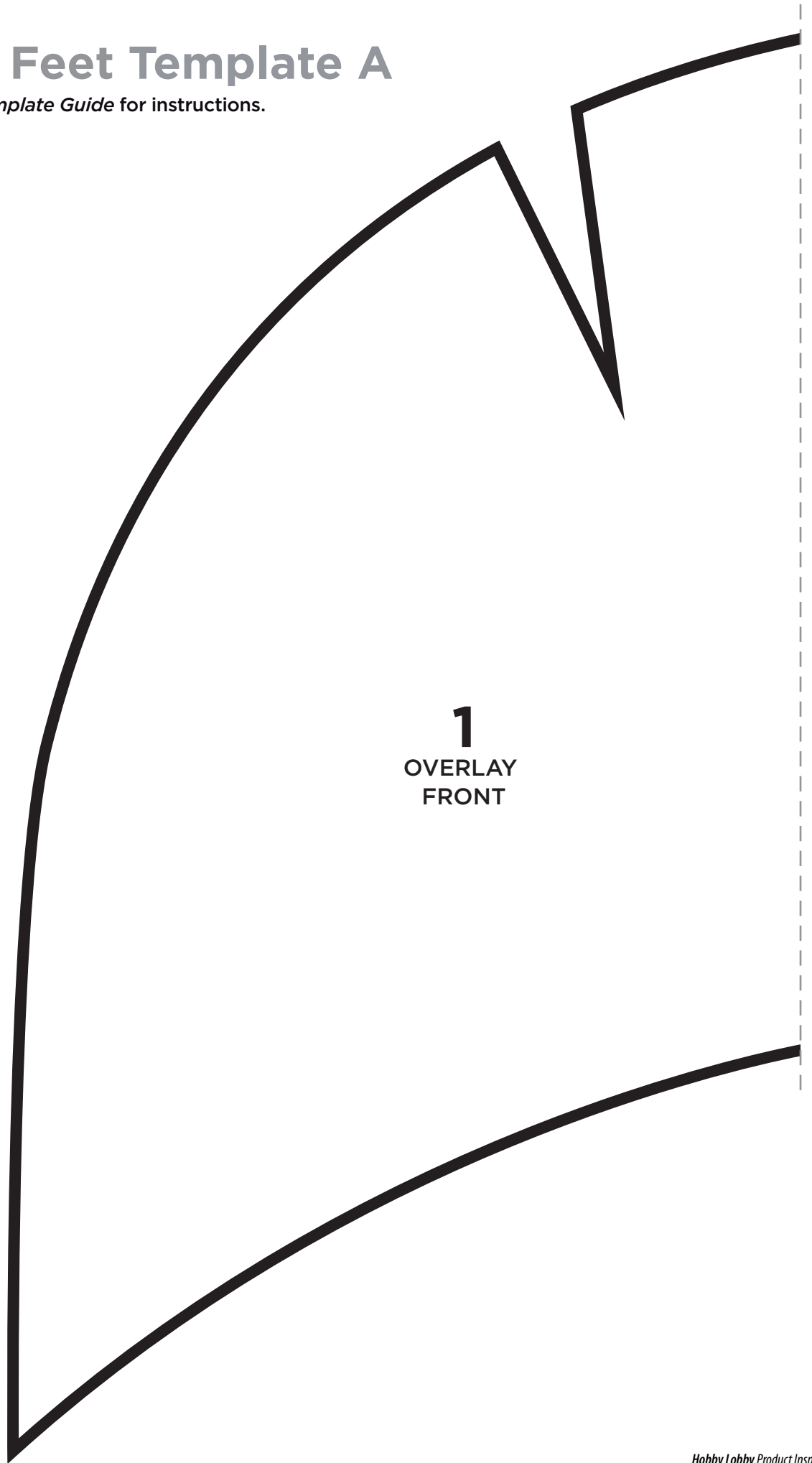

1
OVERLAY
FRONT

Creature Feet Template B

See *Creature Feet Template Guide* for instructions.

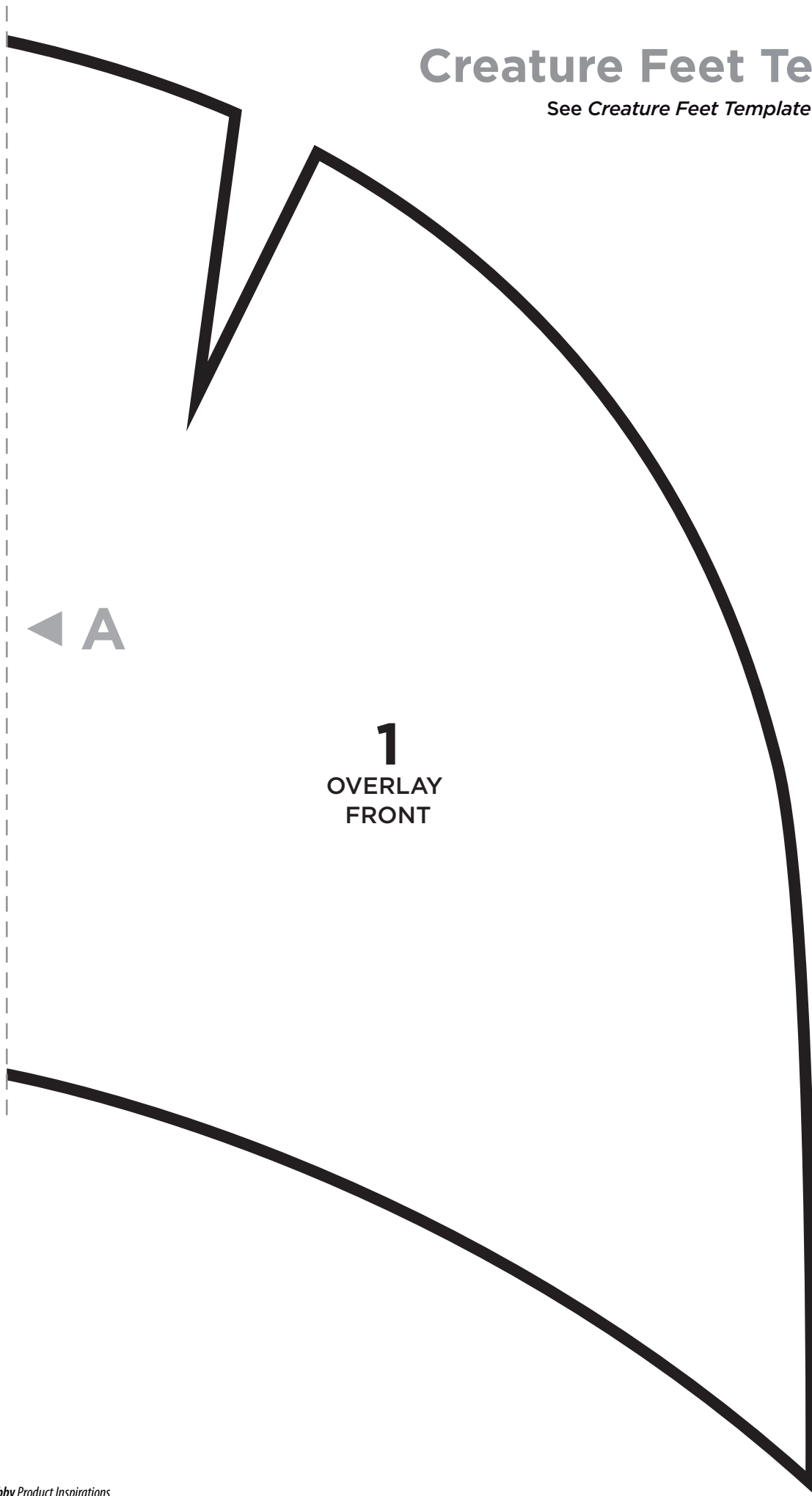

◀ A

1
OVERLAY
FRONT

Creature Feet Template C

See *Creature Feet Template Guide* for instructions.

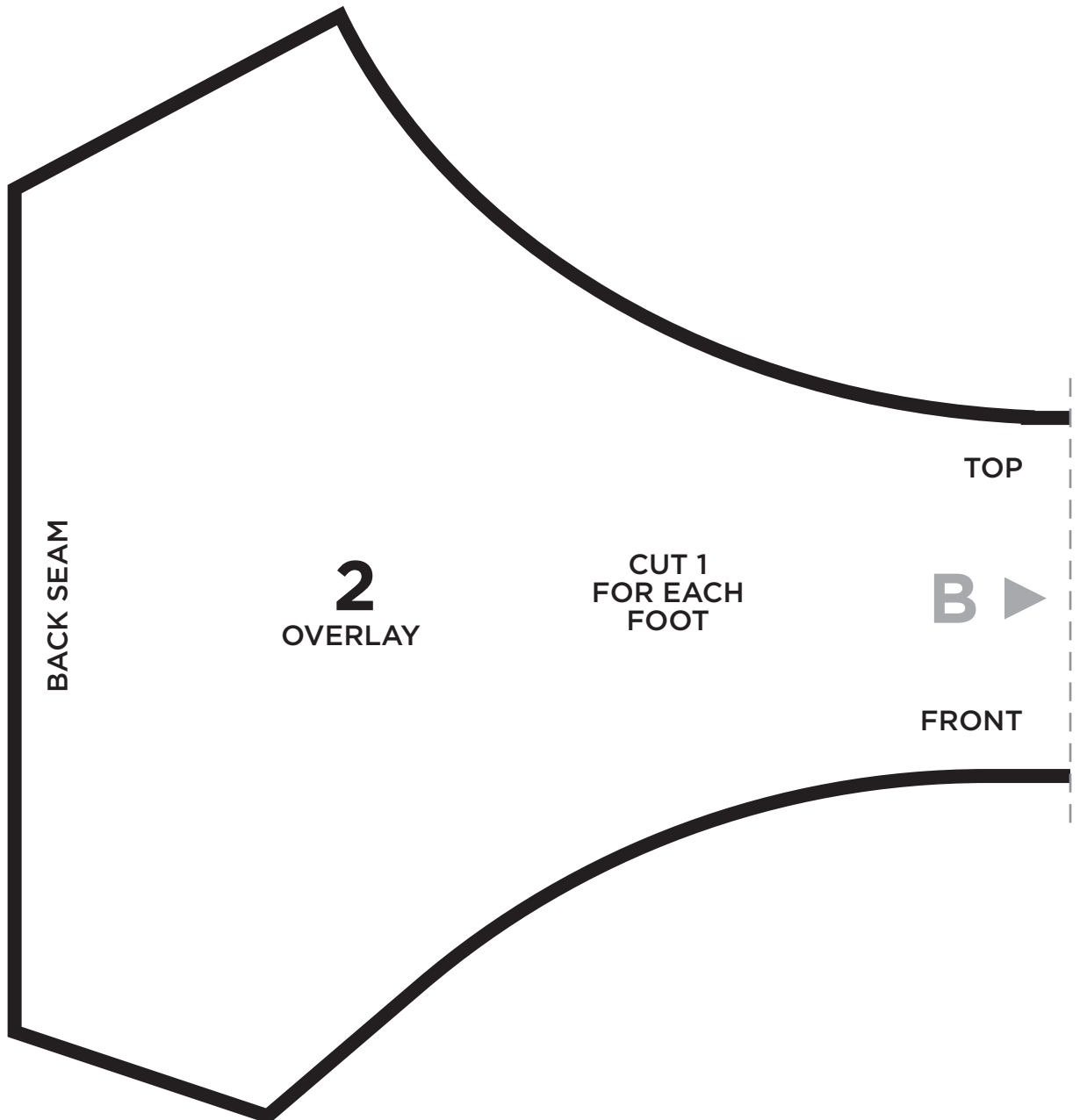
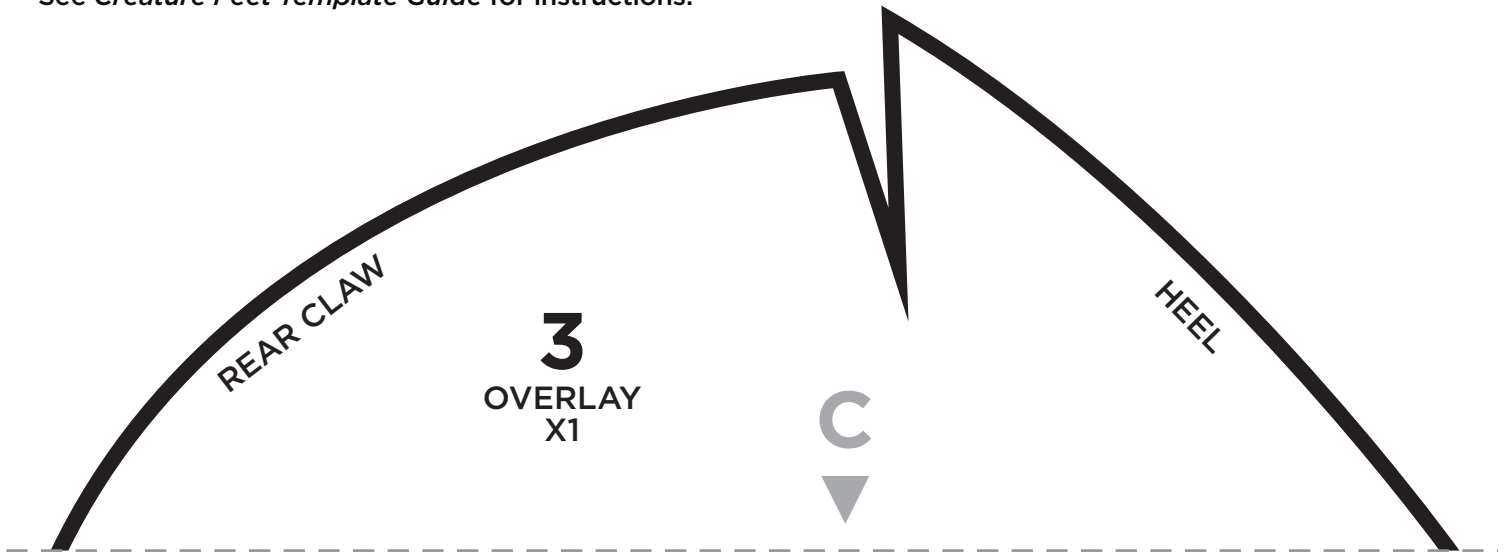

Creature Feet Template D

See *Creature Feet Template Guide* for instructions.

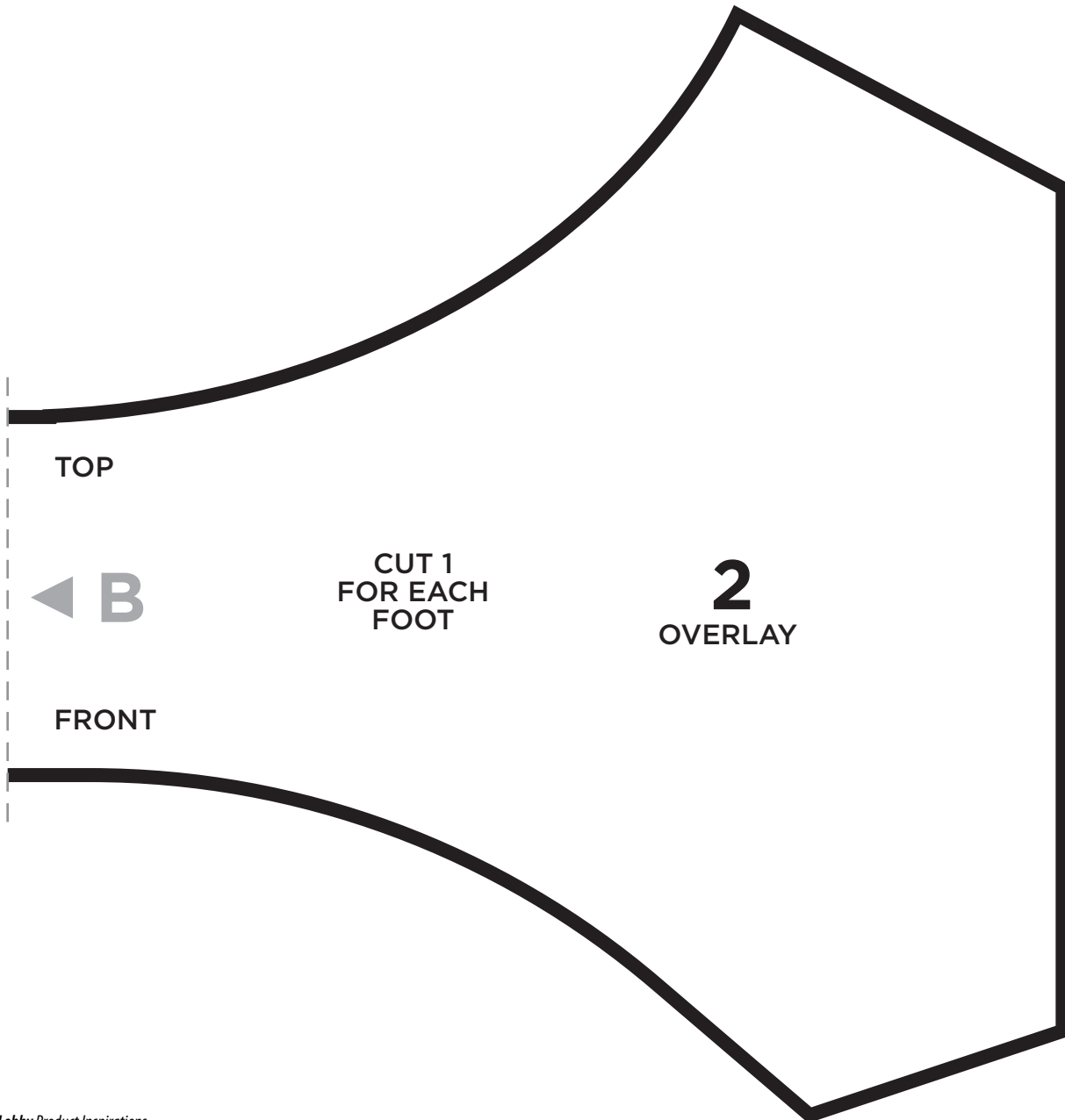
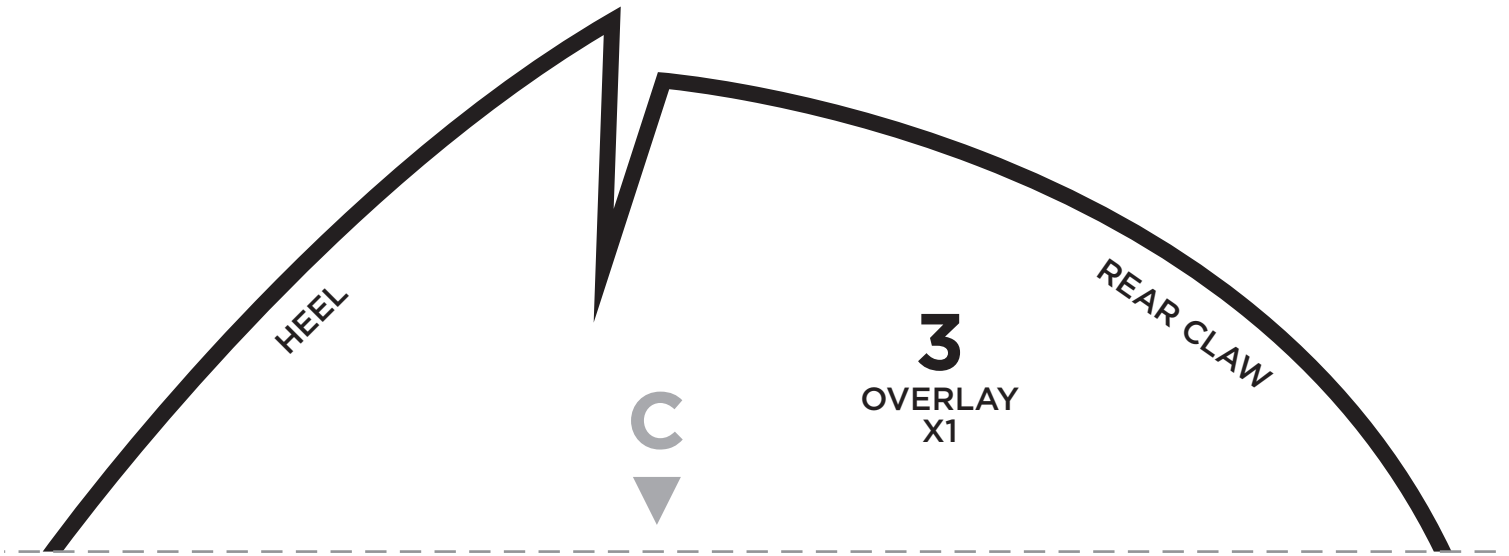

Creature Feet Template E

See *Creature Feet Template Guide* for instructions.

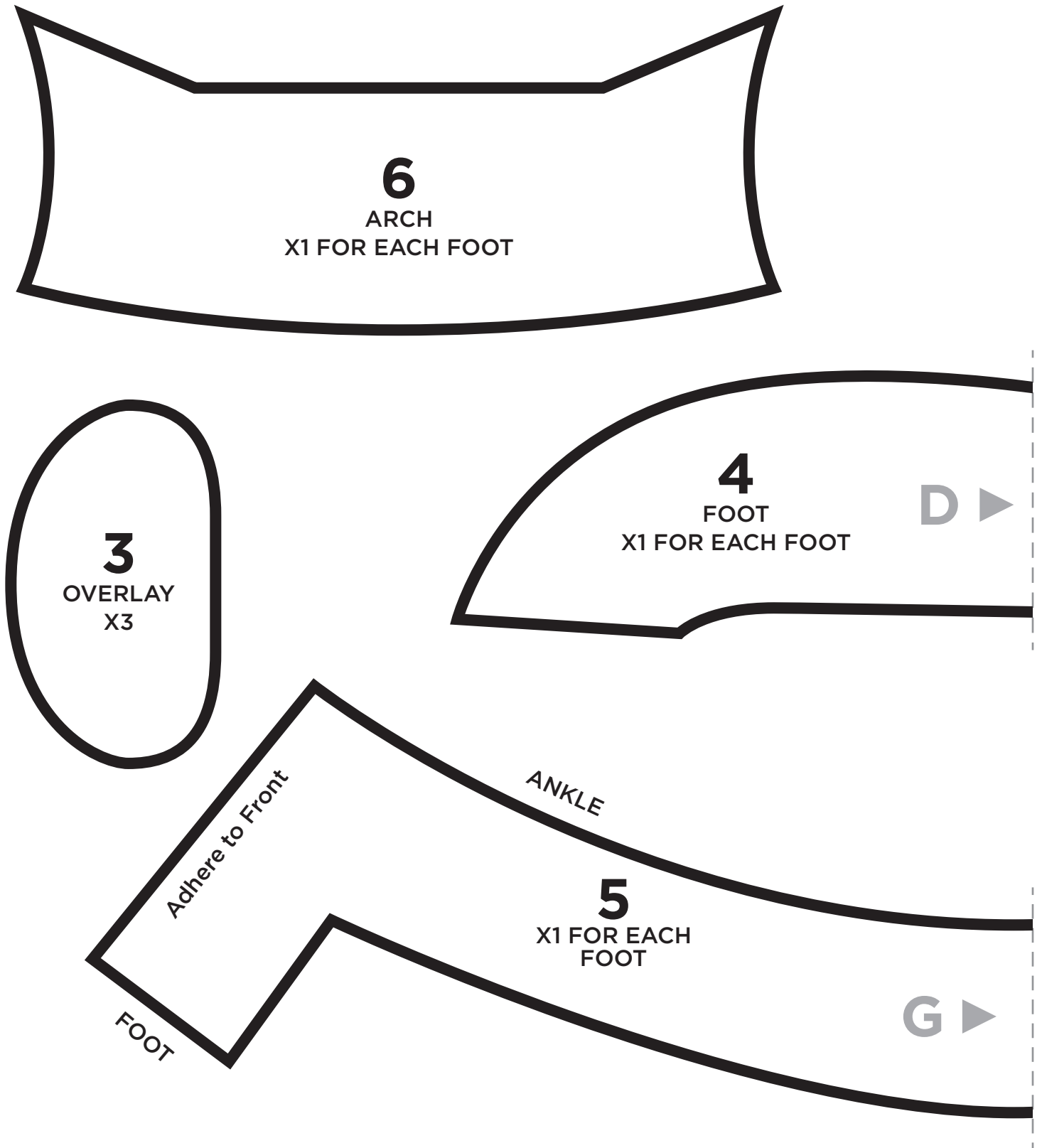

Creature Feet Template F

See Creature Feet Template Guide for instructions.

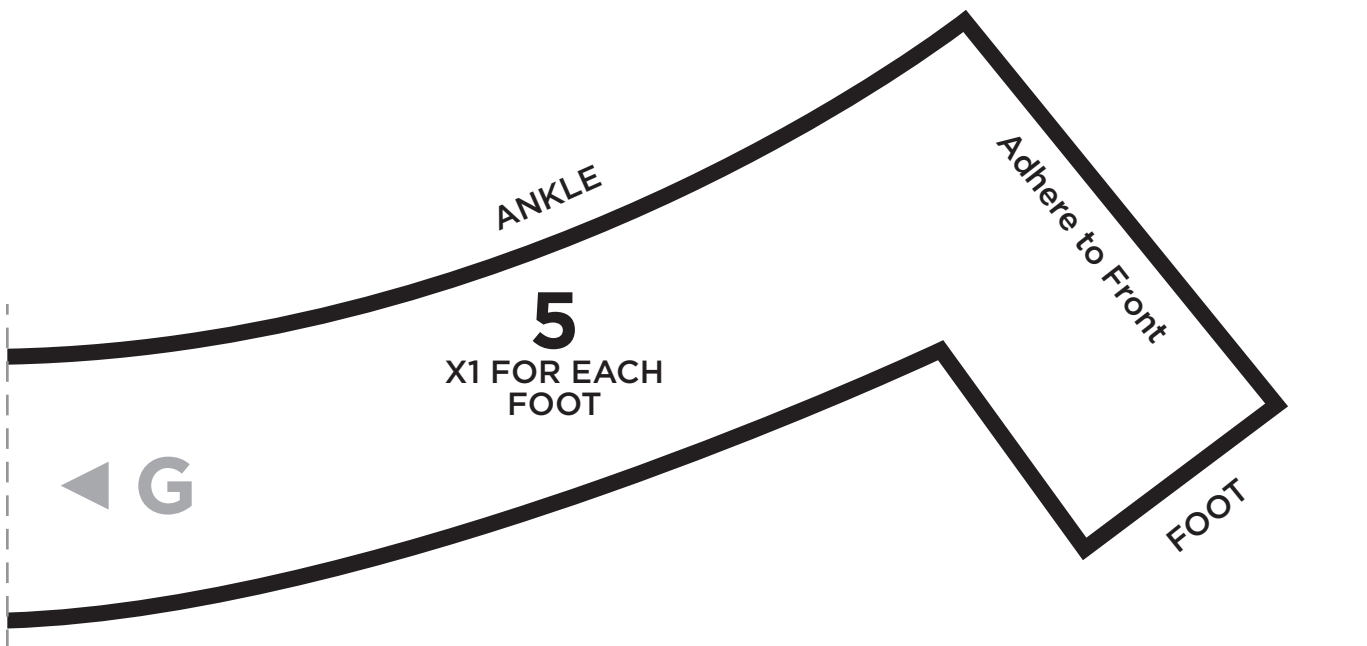
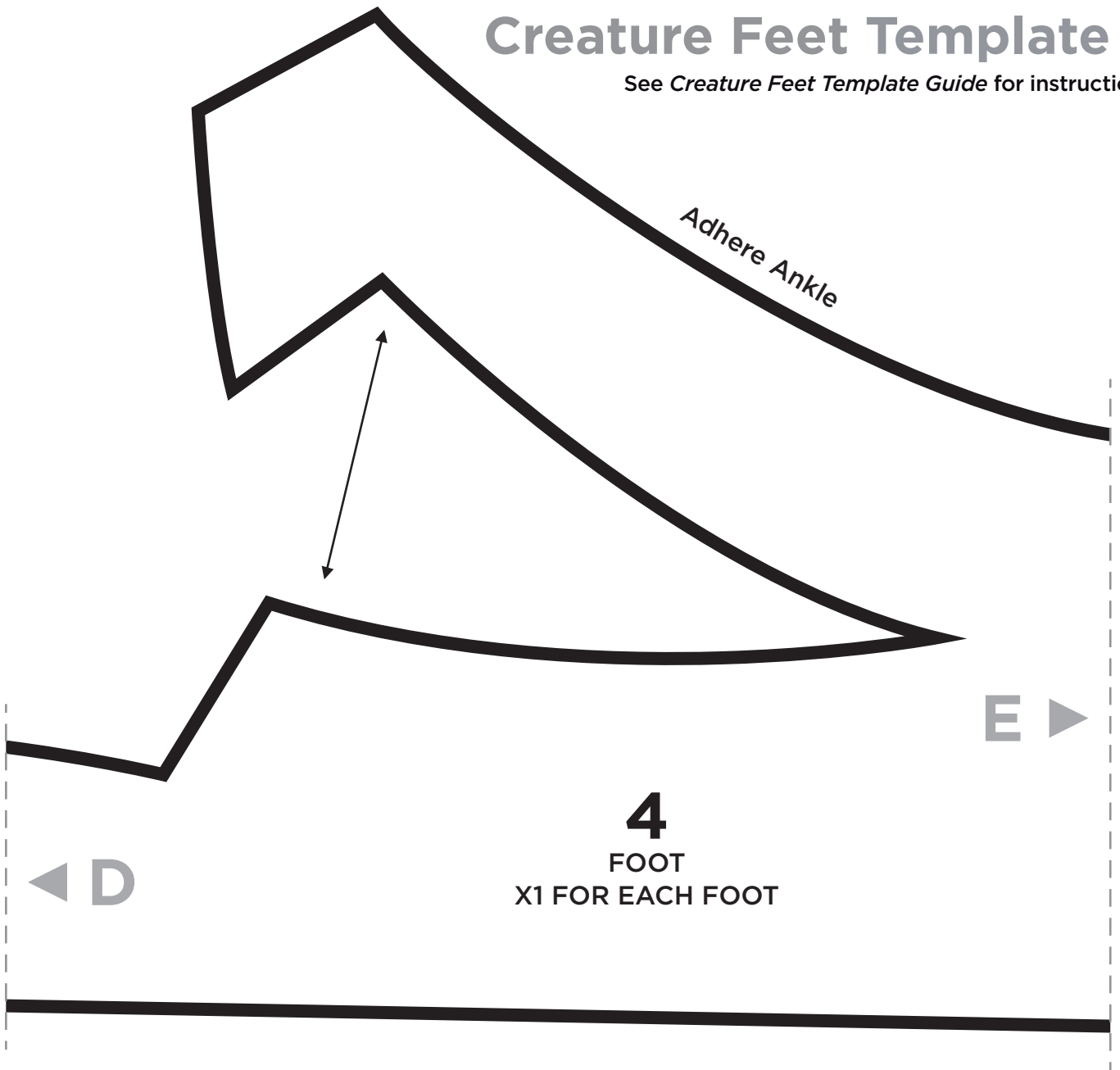

Creature Feet Template G

See *Creature Feet Template Guide* for instructions.

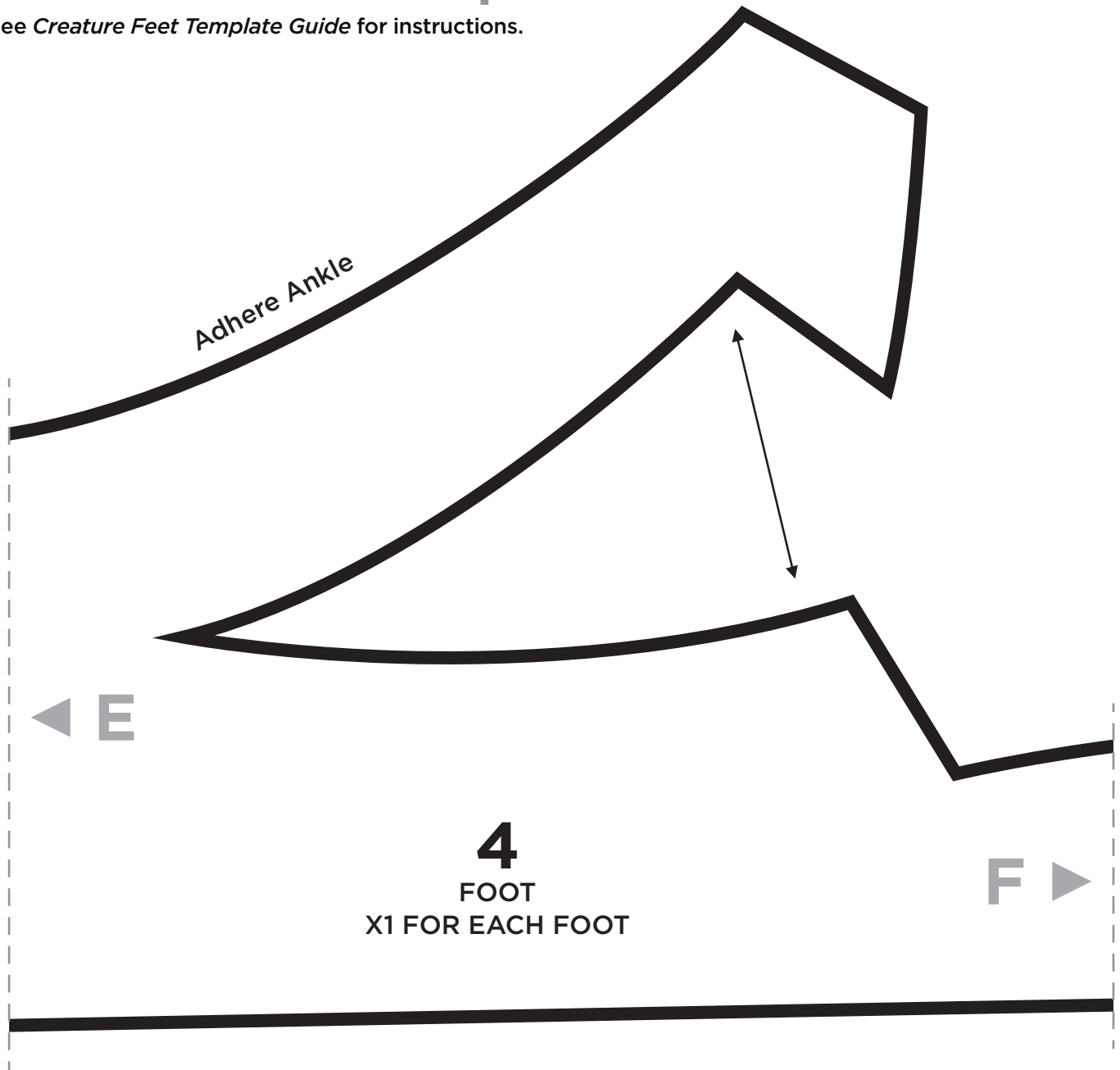

Creature Feet Template H

See *Creature Feet Template Guide* for instructions.

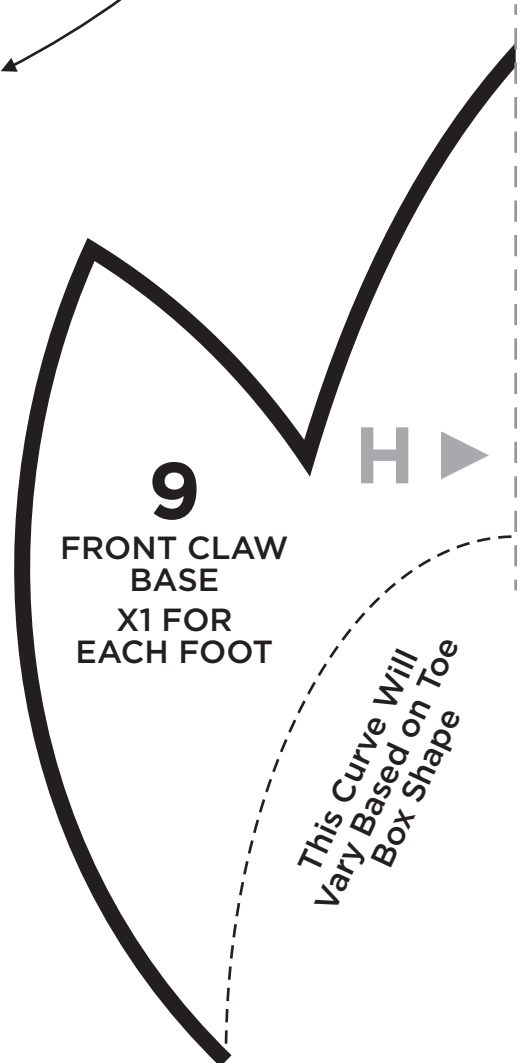
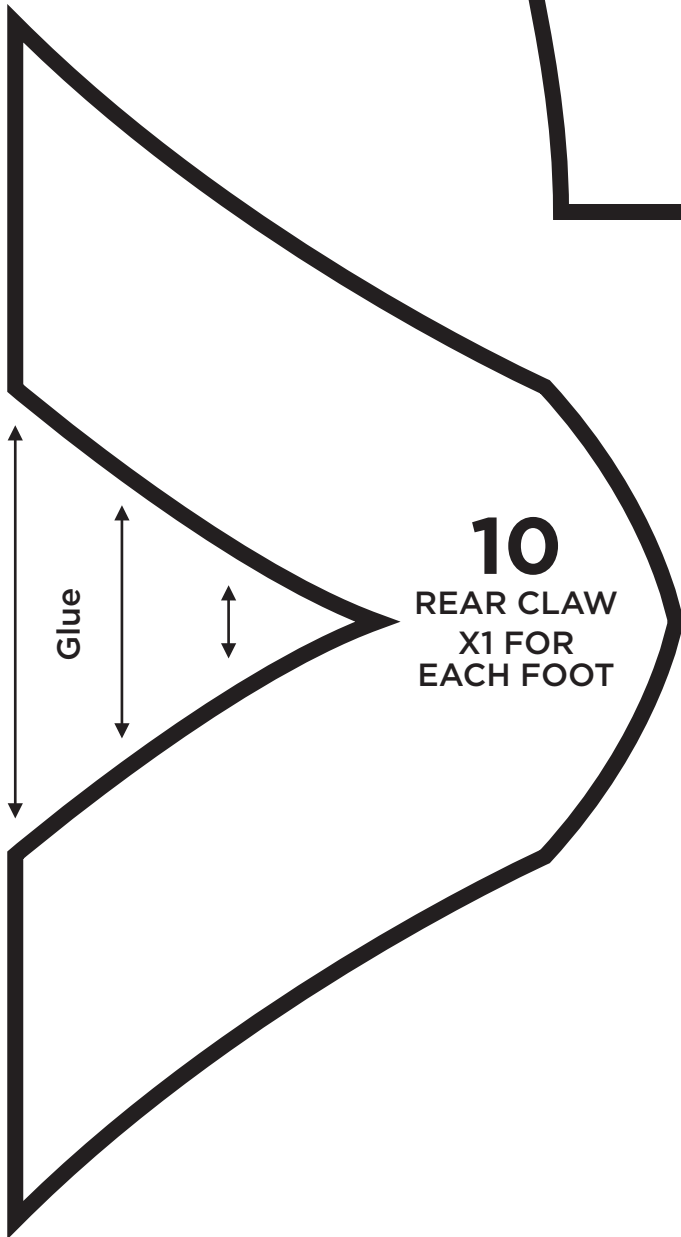
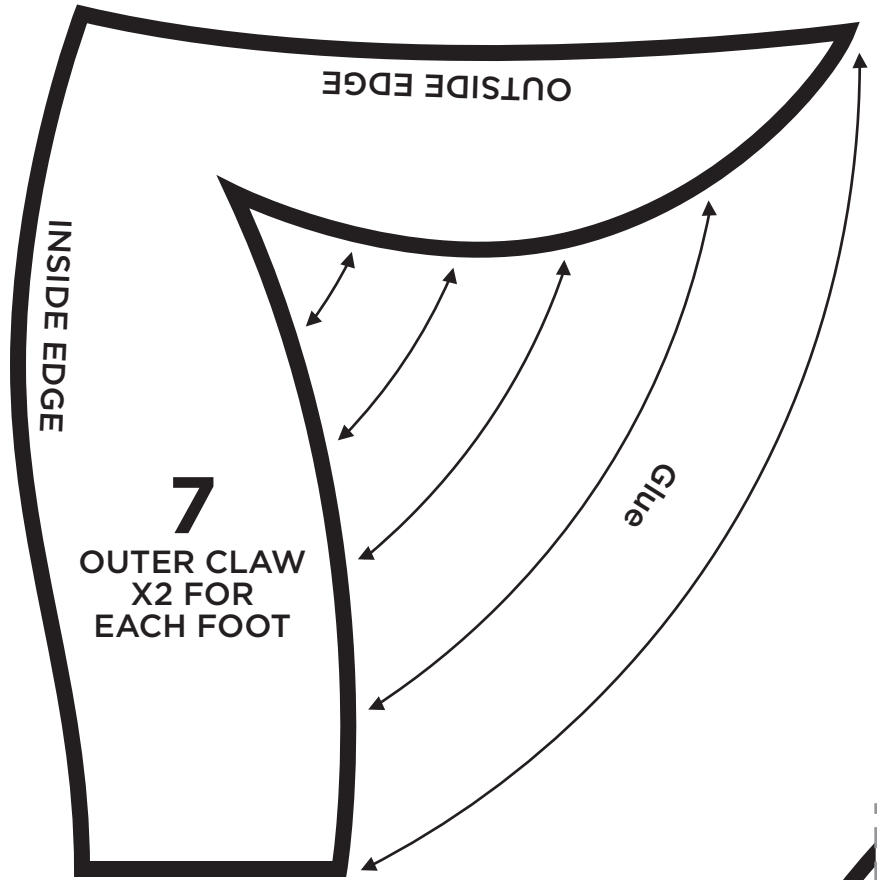

Creature Feet Template I

See *Creature Feet Template Guide* for instructions.

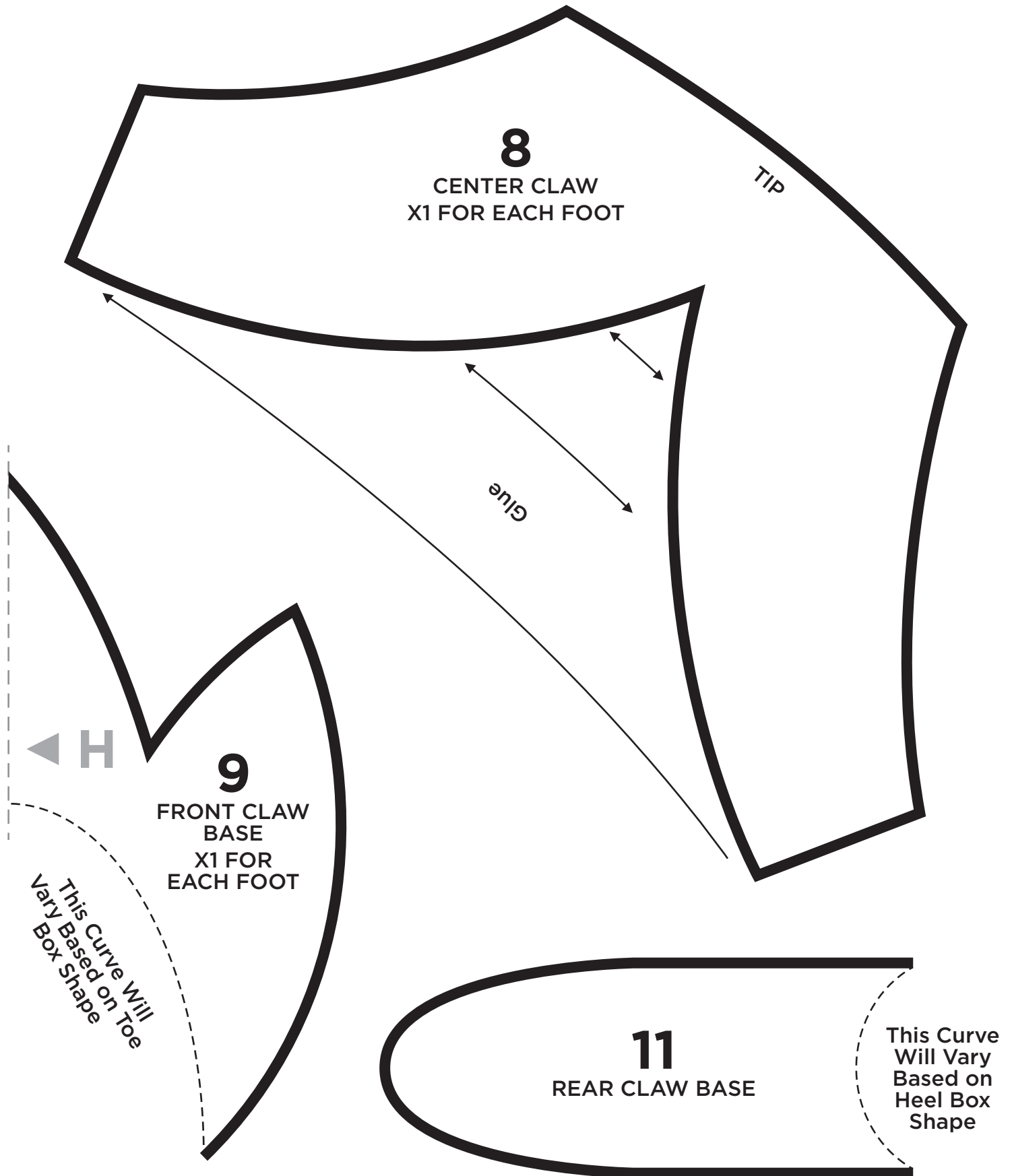

WING IT

It's time to spread your creative wings and fly! Adding a layer of transparent organza fabric in between the foam wings creates beautiful dimension.



SCALE UP

For a little extra flair, we sandwiched iridescent PVC trim in between the fins on the cuffs and earpieces.

Tip: Shape the fins out of air-dry foam clay or moldable plastic pellets.



LACING

The ribbon laces on each mermaid cuff must be reinforced with foam tabs. The additional layer of foam ensures the wristwear won't tear when the laces are tied.

STEP 1

Punch holes into cuff and tab. Apply rubber cement to both pieces (this adhesive only sticks to itself, so it must be applied to each piece of foam).

STEP 2

Adhere tab, making sure holes on cuff line up. Thread ribbon for laces.



Mermaid Cuff Template Guides

- For a full size template, cut out all pieces.
- Size fits youth 8-10 years old.
- Scale to desired size.



Mermaid Cuff Template A

See *Mermaid Cuff & Ear Template Guide* for instructions.

1
x2

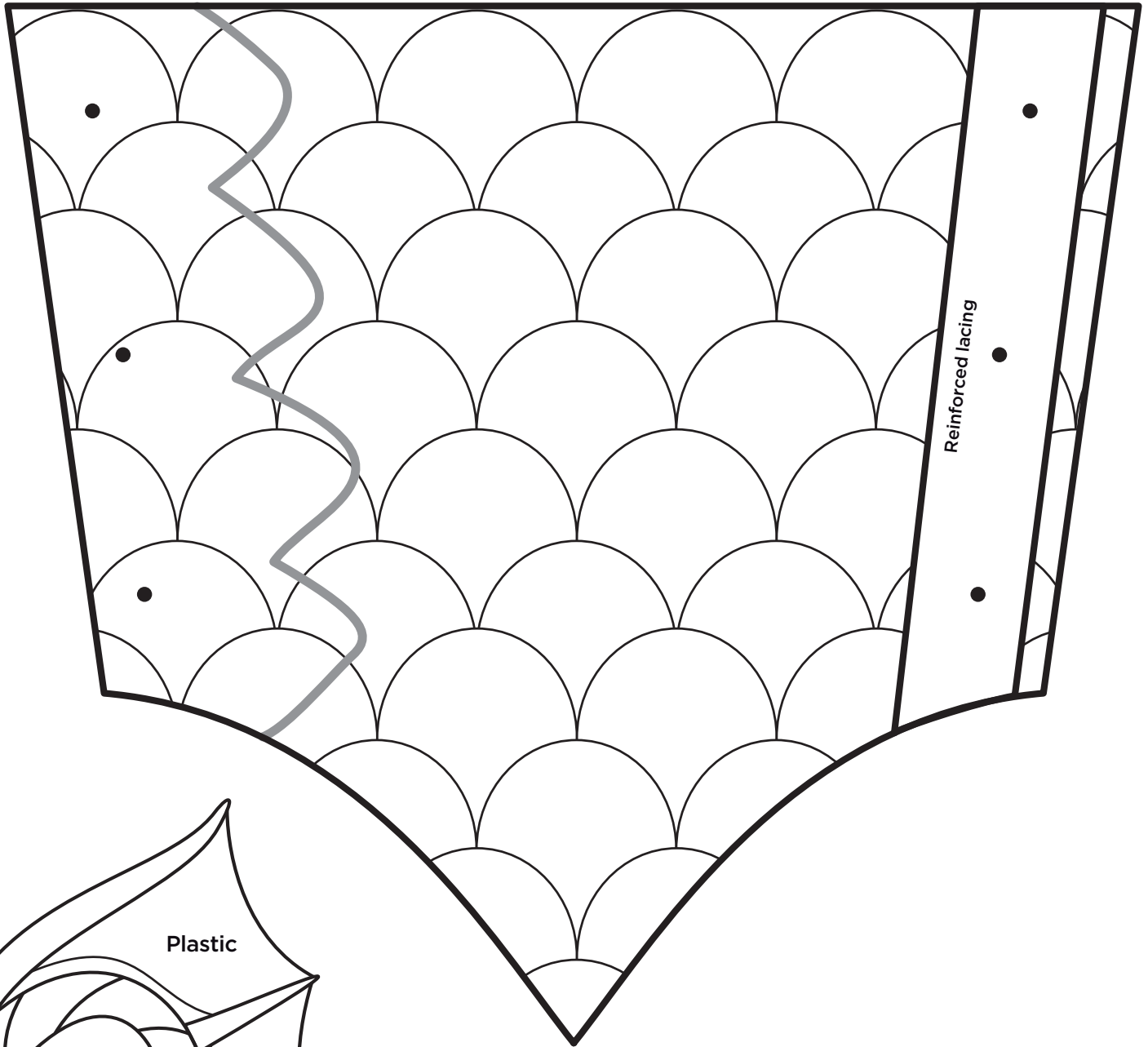

Plastic

3
x2

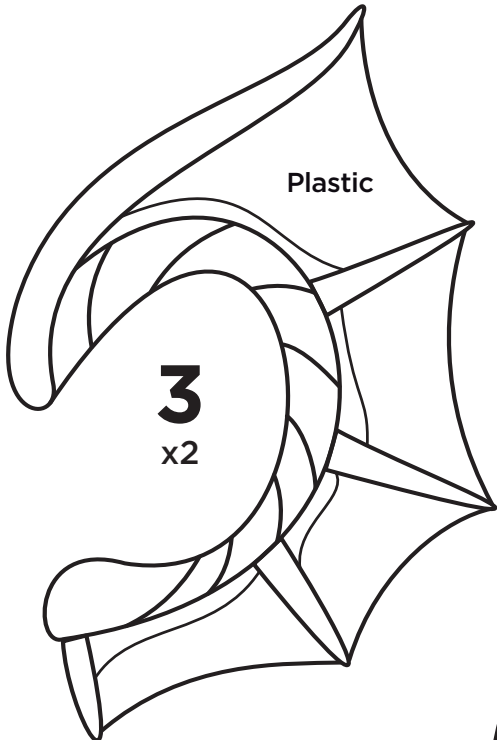

2
x2

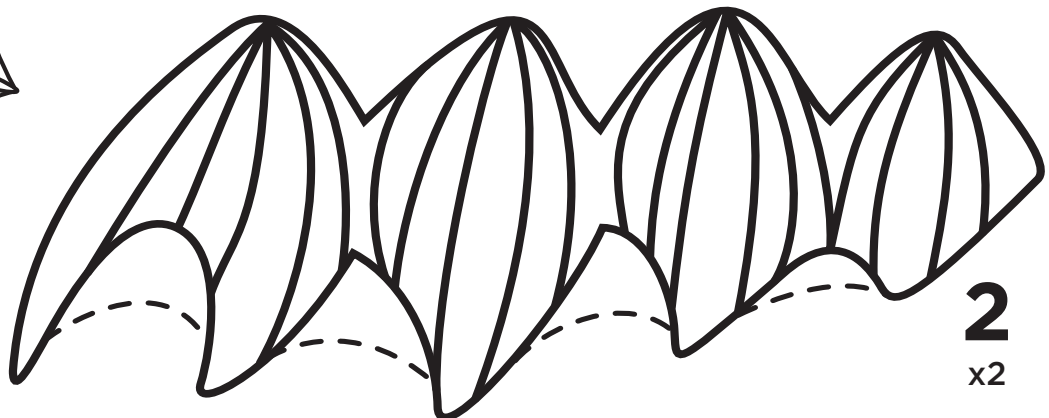

SANDWICHING

Insert a bit of beauty into a pair of foam butterfly wings! We sandwiched colorful organza fabric between two layers of foam to create these whimsical wings.

Note: Rubber cement only sticks to itself, so it must be applied to both the fabric and the foam.

1. Cut out foam wings and organza fabric.
2. Apply rubber cement to insides of wings.
3. Apply rubber cement to fabric and align with wings.
4. Sandwich fabric between wings.



Butterfly Template Guide

- For a full size template, cut out all pieces.

Align arrow ends and tape template together.

- Size fits youth 8-10 years old.
- Scale to desired size.

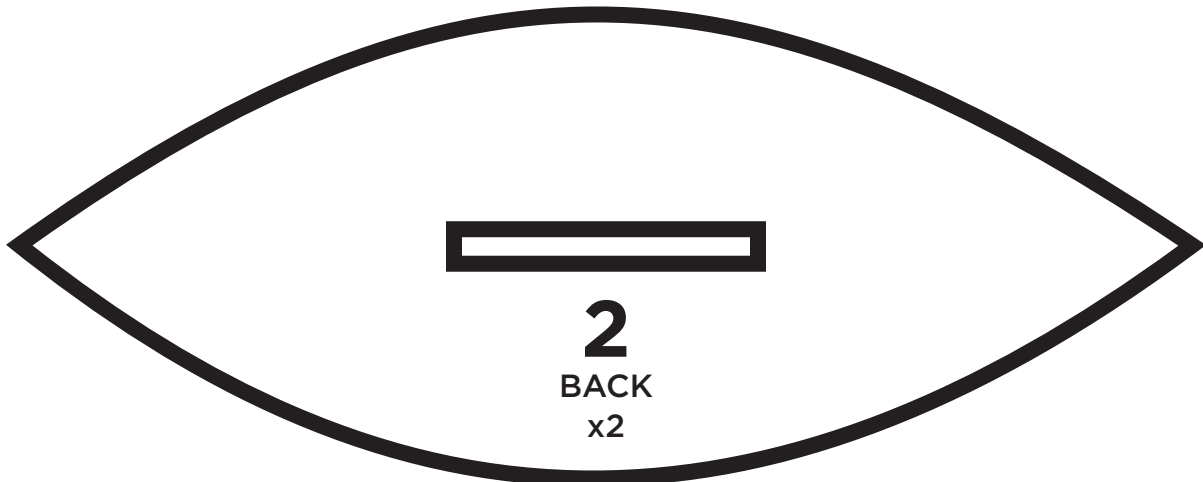

Butterfly Template A

See *Butterfly Template Guide* for instructions.

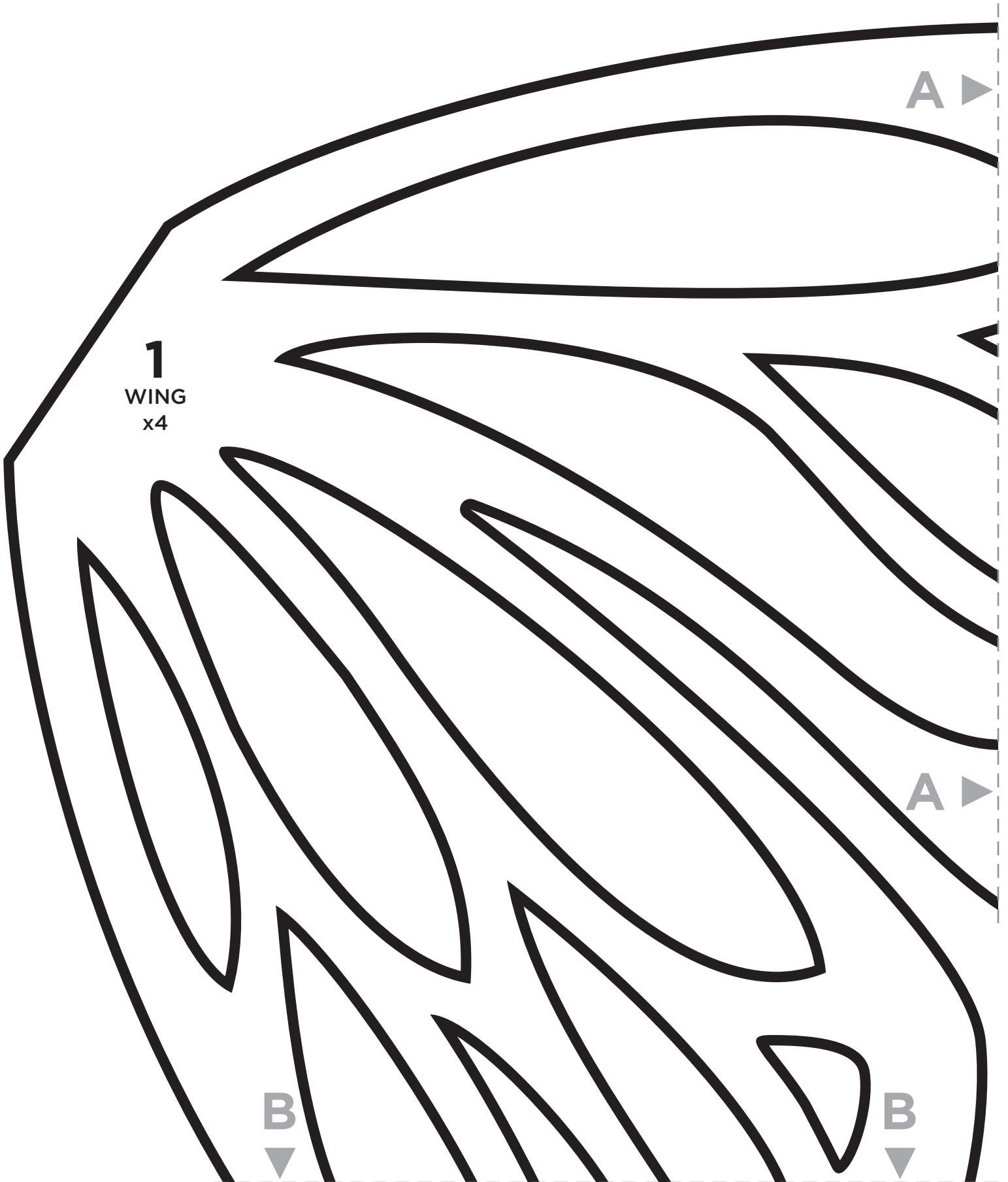

1
WING
x4

A ▶

A ▶

▼
B

▼
B

Butterfly Template A

See *Butterfly Template Guide* for instructions.

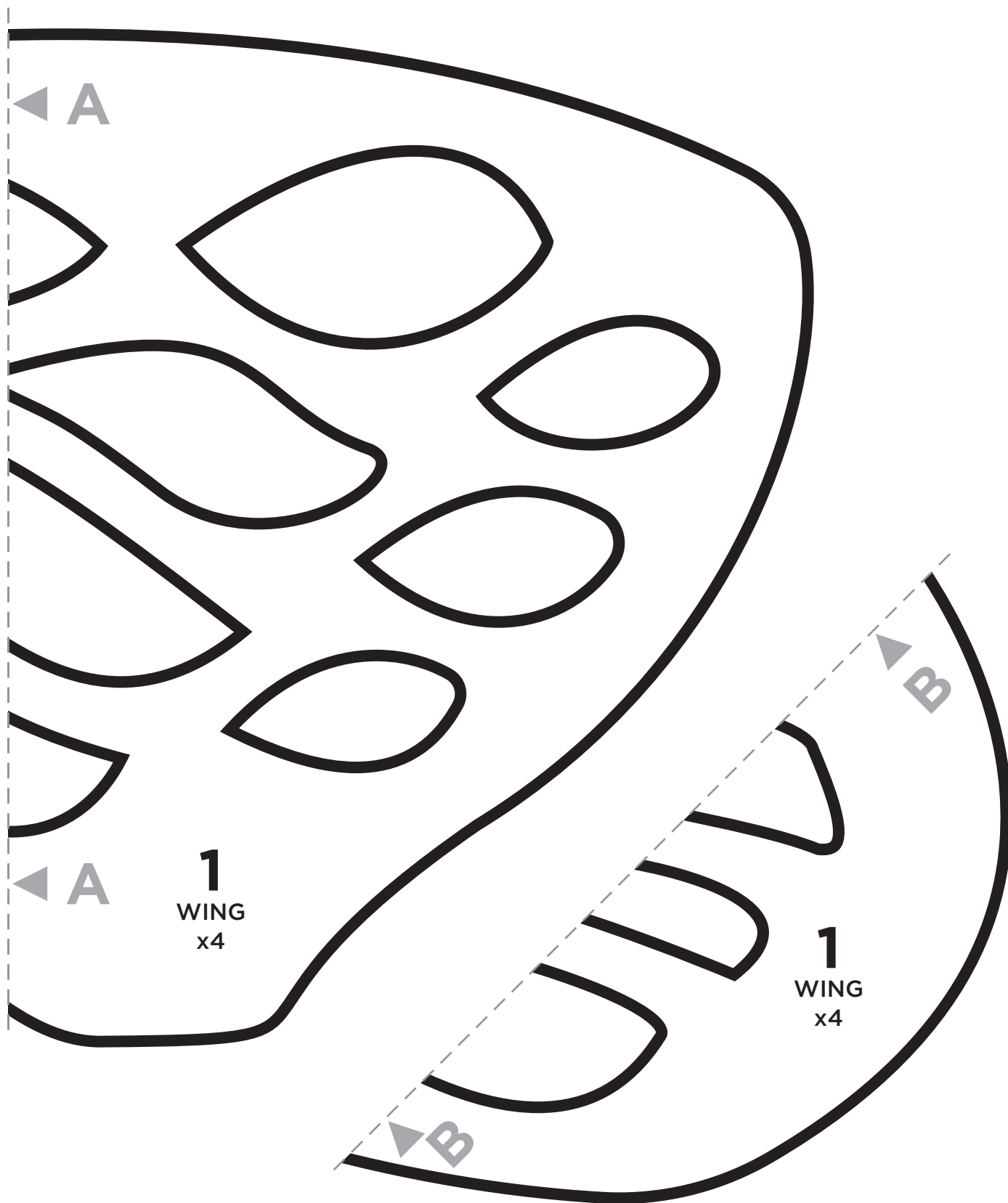

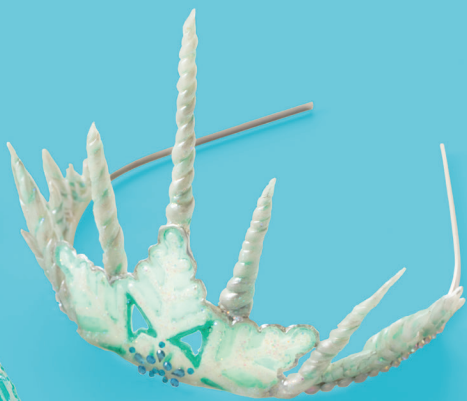

MOLDABLE PELLETS

When heated, moldable plastic pellets take on a waxy consistency that can be shaped into countless designs—like snowflakes, icicles and more!

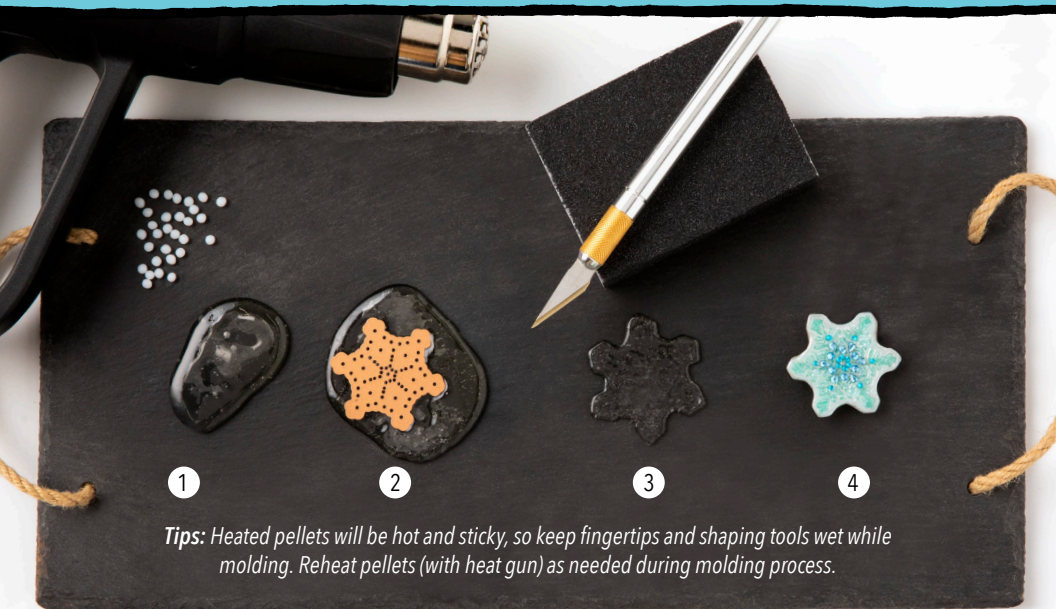

Tips: Heated pellets will be hot and sticky, so keep fingertips and shaping tools wet while molding. Reheat pellets (with heat gun) as needed during molding process.

1. Heat pellets following package instructions (pellets turn clear when heated and return to white when cool).
2. Press snowflake die-cut into surface of heated pellets.
3. Let pellets cool somewhat, allowing them to become solid but still soft enough to cut (taffy-like consistency is ideal). Cut around die-cut with craft knife. Remove die-cut and sand edges.
4. When snowflake is completely cool, paint and embellish as desired.

Snow Shoe Template Guide

- For a full size template, cut out all pieces.
- Align arrow ends and tape template together.
- Size fits youth 8-10 years old.
- Scale to desired size.

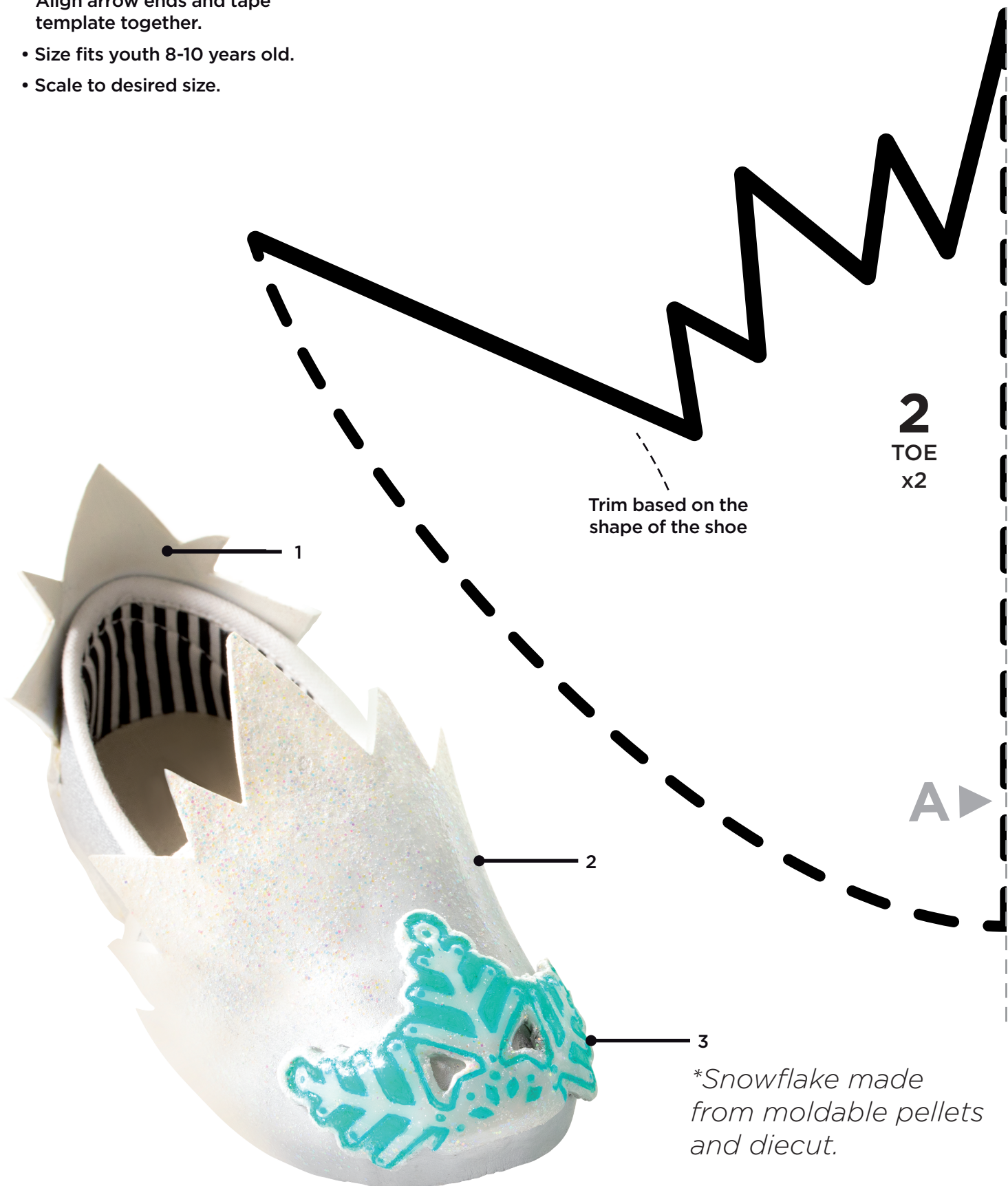

Snow Shoe Template A

See *Snow Shoe Template Guide* for instructions.

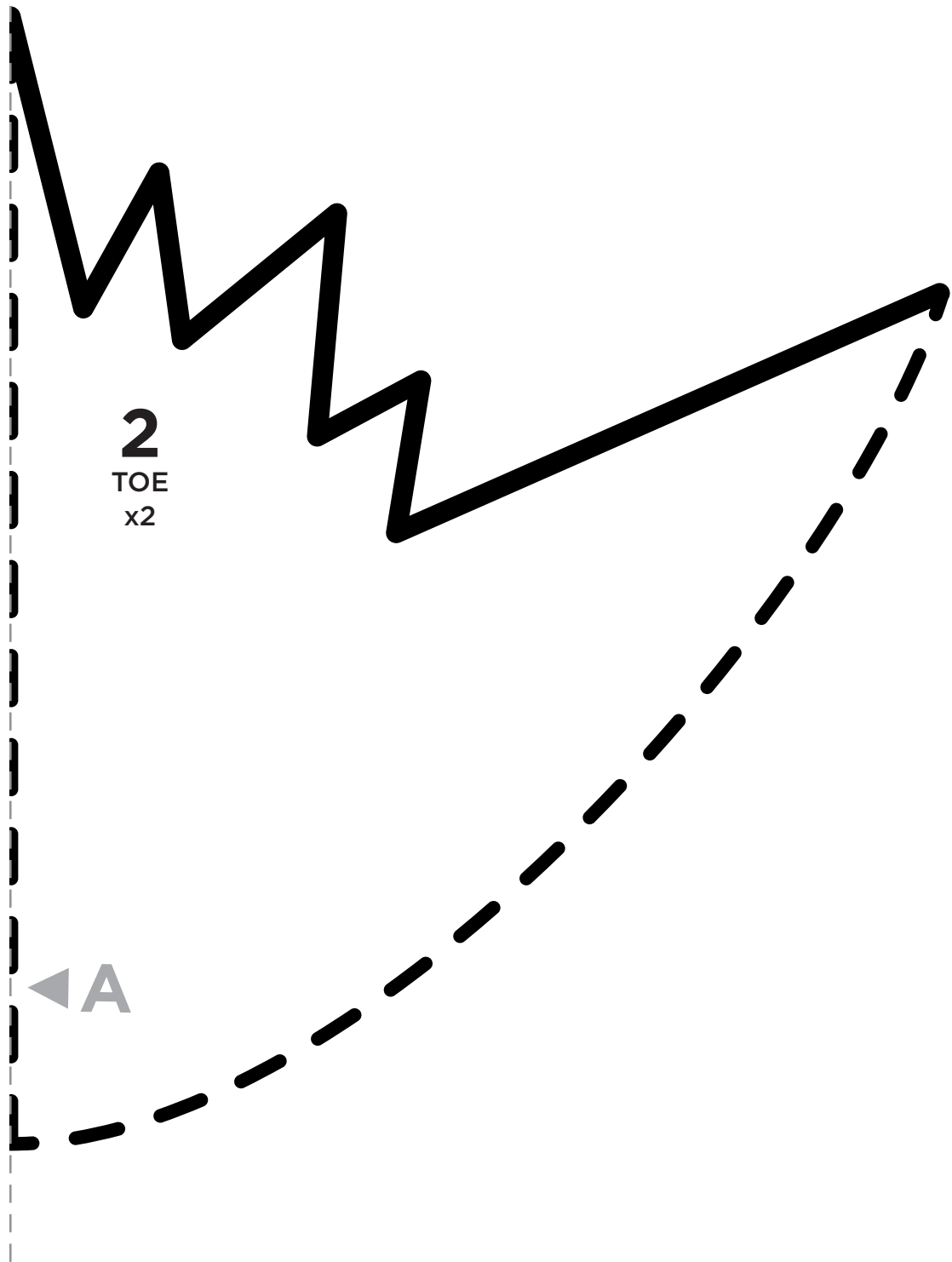

Snow Shoe Template B

See *Snow Shoe Template Guide* for instructions.

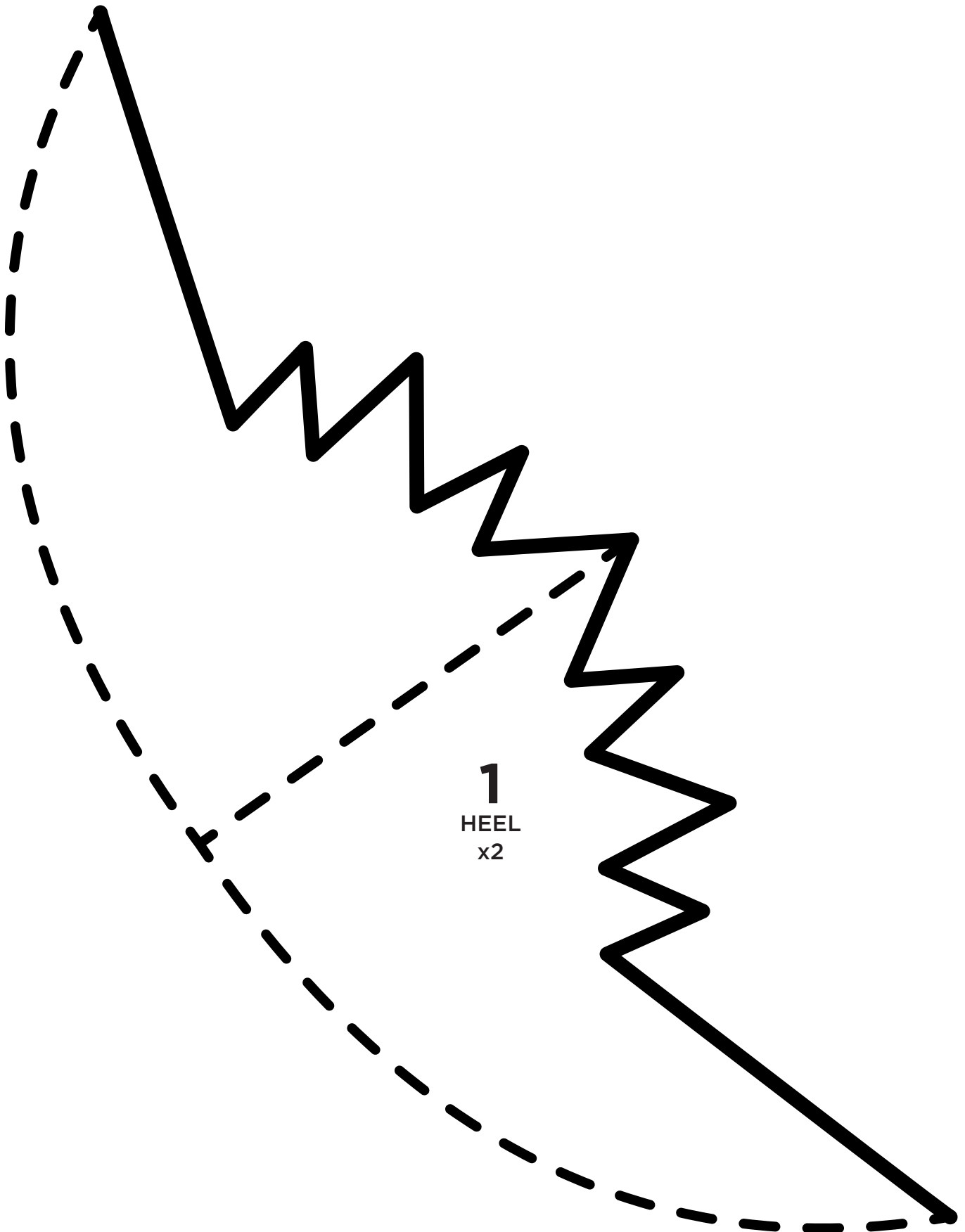

ADDITIONAL TIPS:

Instead of threading the ribbon through holes or slits in the foam leaves, thread them through foam tabs. This method ensures the leaves won't rip or tear when the ribbon is tied.



Adding hook-and-loop straps to the sides of the armor makes it adjustable! Reinforce the straps with foam tabs (see strapping technique).



We connected the visor to the helmet with long fasteners (find them in Scrapbook & Paper Crafts). The brads become hinges, allowing the visor to easily pivot up and down.



Use braided elastic to create stretchy, comfortable shoulder straps. Just knot the elastic into loops and feed it through a slit in the foam (see template).



To connect our pixie wings, we sandwiched twisted wire between the layers of each wing. This method (unlike using elastic straps) gives the wings bounce and movement.



Simply bend the wire into a U-shaped back brace and slide it into the back of a shirt or costume.

FROZEN OVER

Is your foam project feeling too simple? Jazz it up with detailed embellishments—like our snowflake designs—made out of moldable plastic pellets. Just glue them in place and voila!

