

never -----
FELT
----- *better*

10 chic projects
inside!



HOBBY LOBBY®

1



1. LEAVE IT TO FELT

The key to the realism of this felt greenery is to connect the leaves with wire that's wrapped in floral tape and to curl the leaves. Keep scrolling for the leaf templates—there are three sizes, which gives the garland its depth and dimension.

2. CUT IT OUT

Back felt sheets with fusible web to make cutting out custom shapes a breeze. The backing provides stability, which means clean lines and a professional-quality finish. The result? A felt project that's polished enough to function as grown-up décor. The (formerly white) lampshade was dyed with alcohol ink.

2**3****4****3. FLORA AND FELT**

The leaves of this faux houseplant are made up of four layers of felt, stitched together. A craft wire gives them the flexibility and stability they need to look real. Leave an opening at the bottom of each leaf for the wire, and stitch on a tube of felt to cover the end. Then bend the stems into the ideal arrangement.

4. PILLOW FELT

Handmade felt appliques mean endless opportunities for customization. Here, the felt is adhered to the pillow form with fusible web, making this a beginner-friendly DIY. The stitches are decorative.

5



6



5. STAY IN PLACE

Try backing felt sheets with stiffened felt for fabric crafts that need to be able to stand on their own. Then grab the templates (just keep scrolling!) for these planters.

TIP: Double layer the regular felt sheets for extra sturdiness.

6. FELT THE ROSES

Lightweight and flexible, felt is a great material for crafts that hang. Adhere the letters to the pennants with fusible web, then embellish with bouquet-worthy felt flowers. Here's how to make them: Spiral a circle of felt, then (starting in the center) roll the felt in on itself, gluing to secure.

7. FELT LIKE HOME

A felt makeover was just what these paper-mache boxes needed to upgrade them from storage status to décor status. Adhere panels of felt to the boxes, then embellish them with embroidered felt and fabric details.

HINT: The mushroom-cap roof is needle felted.



8. HEART FELT

This plumage is all courtesy of felt: hearts for wings and scalloped strips for chest ruffles. Use fabric adhesive to secure the feathers to a foam form (shaped with a hot wire cutter).

TIP: To make the feet, twist three pieces of wire together, then open up the ends.

ON THE COVER: This book cover is made of four pieces of felt: the outer part is two sheets fused together and the inside flaps are two separate pieces.

TIP: Reinforce the edges with blanket stitches.



9. FELT UNDERCOVER

This cover is made of four double-layered pieces of felt: a front, a back and two sides. Leave the top few inches unstitched so the sides can be folded in. Then secure the top corners with strips of leather (just knot them through slits cut into the front and back pieces).

TIP: The letters were cut from faux-leather felt.

HINT: Leave the top and bottom open to make grabbing (and replacing) tissues a cinch.



10. WREATHED IN FLOWERS

DIY felt flowers are just a few snips and dabs of glue away. Ruffled: Four scalloped circles of felt, tri-folded and glued together. Poppies: Six felt circles layered and glued together, with fringed and rolled strip of felt in center. P.S. The beaded wreath comes readymade from the Floral Department!





11. SPOT THE PURSE

This jungle cat bag has features that make switching it from a traditional purse to a fanny pack super simple: D-rings for the shoulder strap and a strip of felt on the back to slide a belt through. Scroll down for the templates!



12. IT'S A WRAP

Felt is a very durable material when it's reinforced well. Each felt layer of these ear bud wraps is doubled up. And on the inside front flap, under the nose, a circle of felt hides the stitching and gives sewed-on snaps more material to hold onto.



13. CARRY TALE

Faux-leather felt is ideal for projects that have to hold up to everyday wear (here, Simplicity 8356, option C—swap the strap in favor of a wrist band for a style like this). On this purse, the faux leather helps reinforce the hardware and also adds texture contrast.

FELT HOME DECOR

ANIMAL BAG (1 OF 2)

SCALED AT 50%

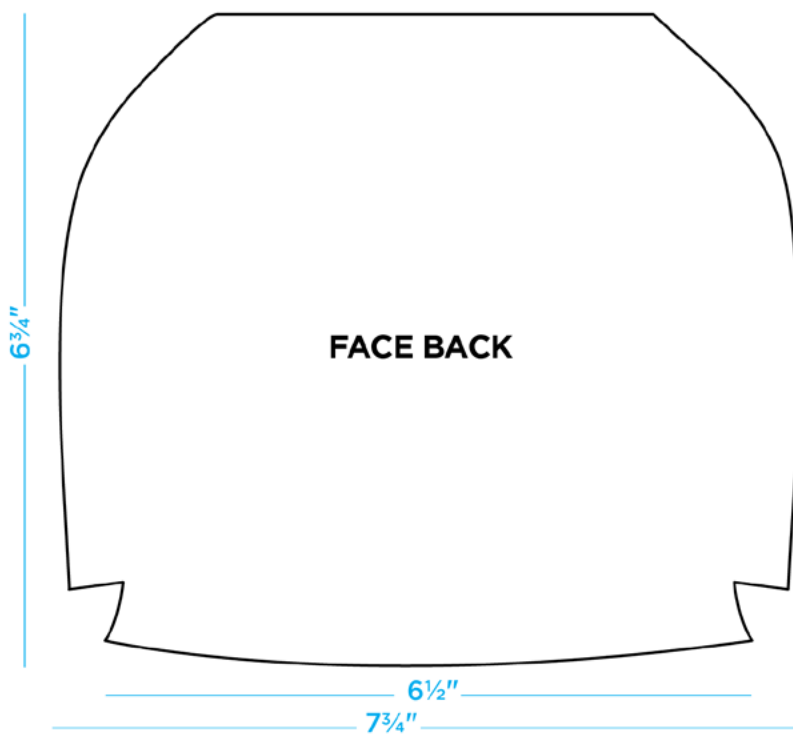
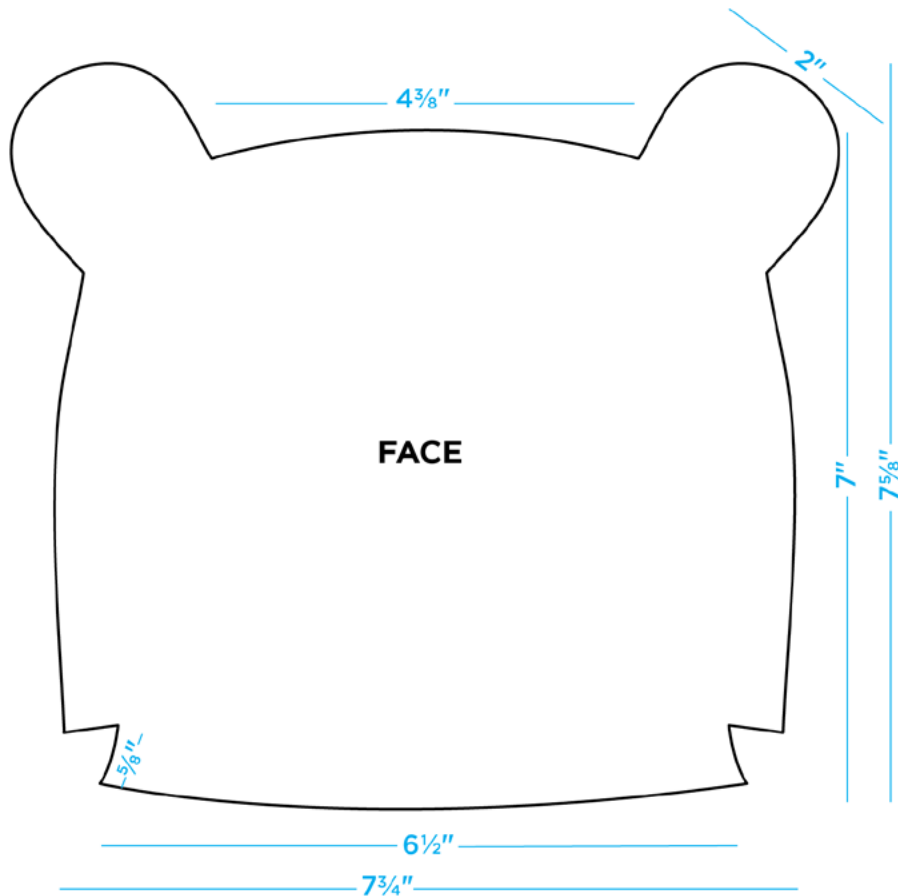

FELT HOME DECOR

ANIMAL BAG (2 OF 2)

SCALED AT 50%

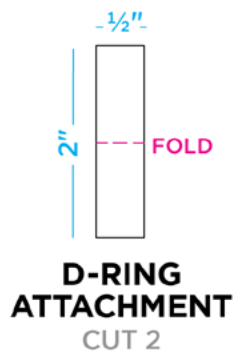
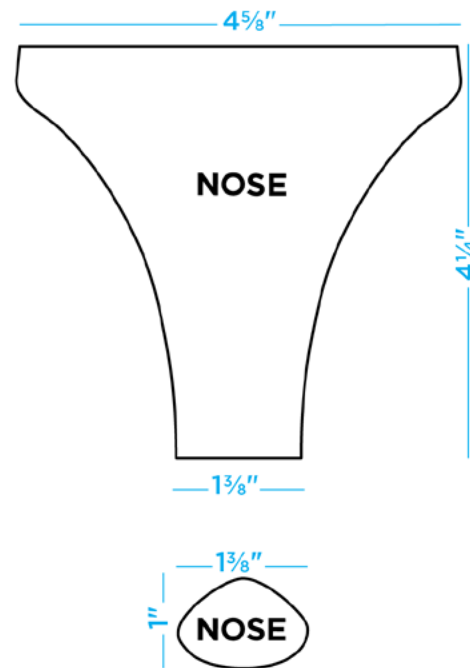
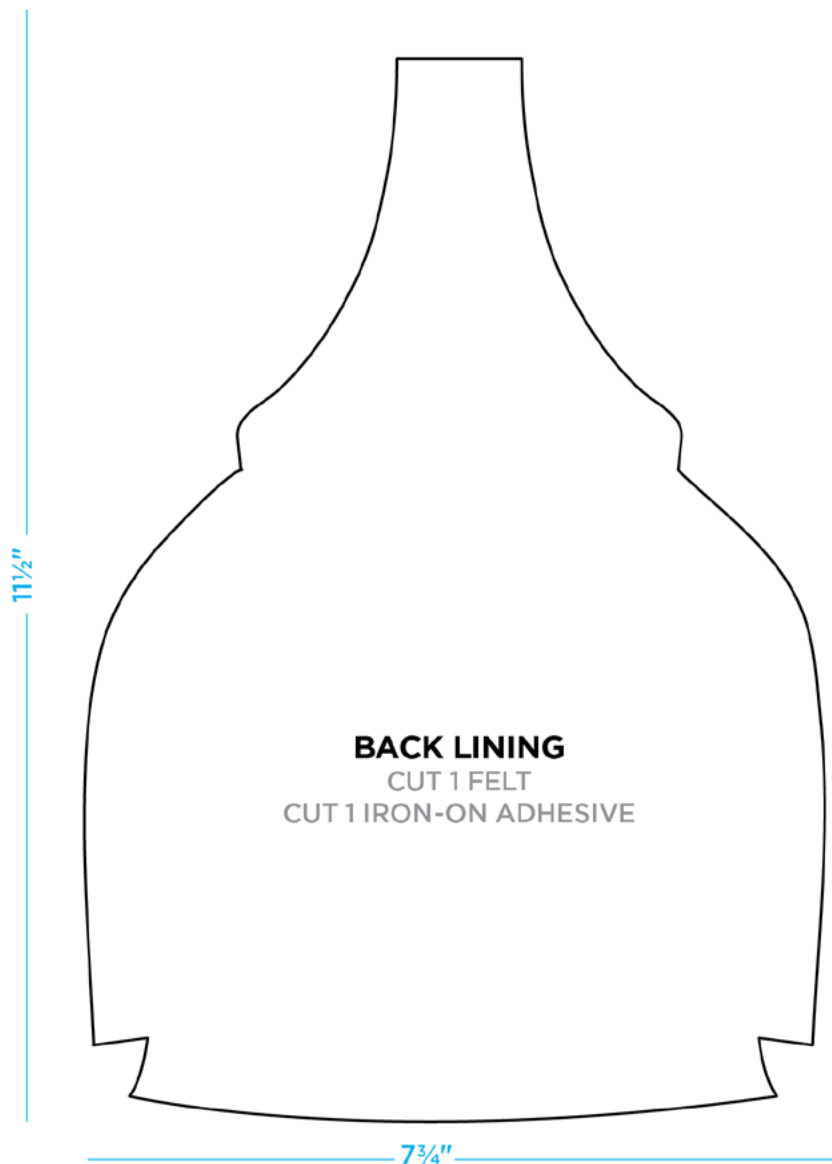

FELT HOME DECOR GARLAND

SCALED AT 100%

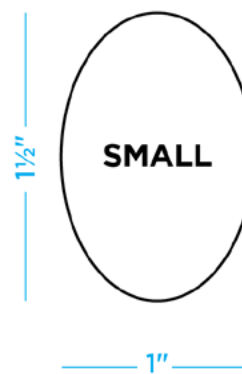
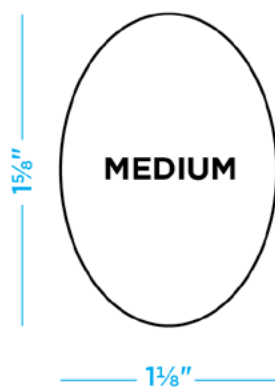
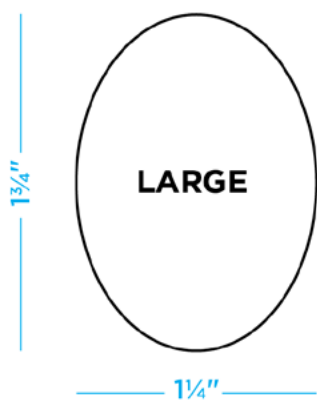

FELT HOME DECOR

SIX-SIDED PLANTER

SCALED AT 50%

For added stability and structure, adhere two sheets of felt together back to back before cutting out template pieces.

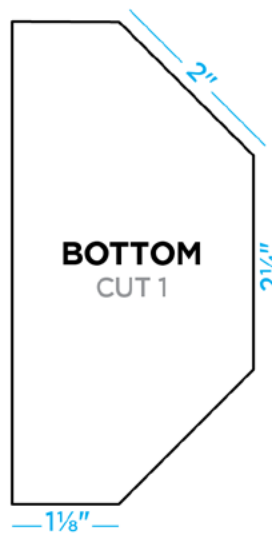
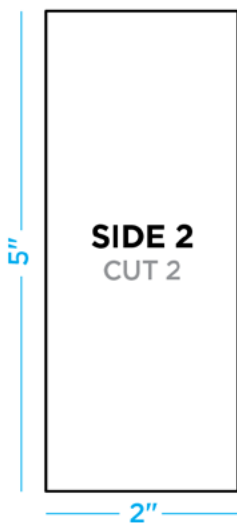
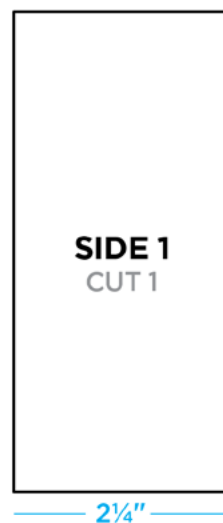
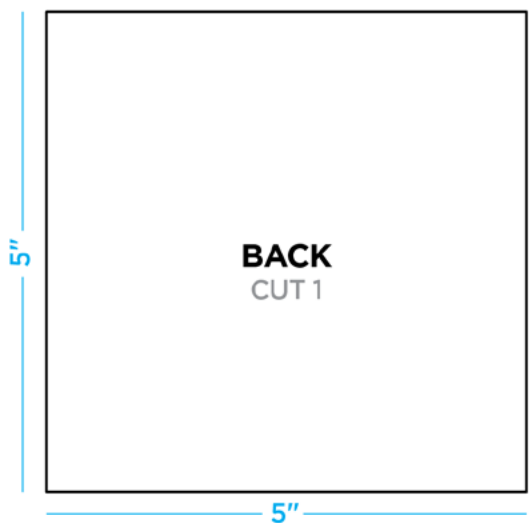

FELT HOME DECOR

FOUR-SIDED PLANTER

SCALED AT 50%

For added stability and structure, adhere two sheets of felt together back to back before cutting out template pieces.

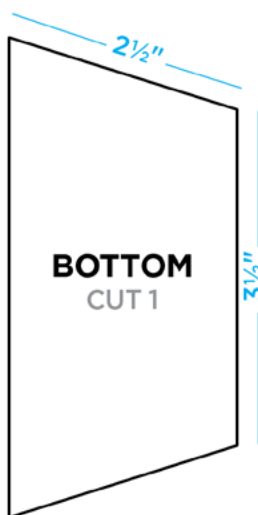
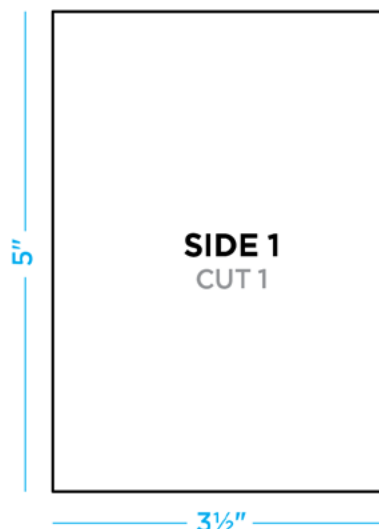
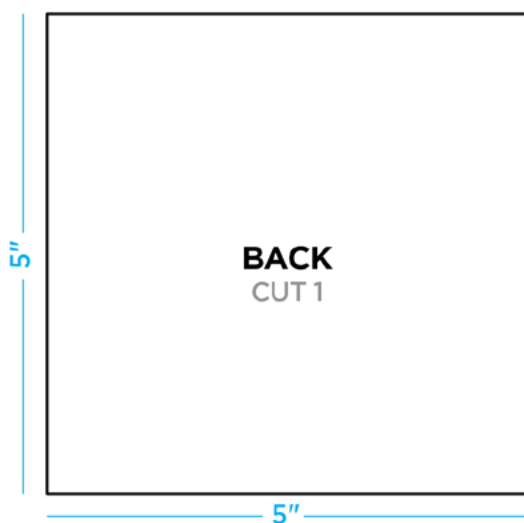

FELT HOME DECOR THREE-SIDED PLANTER

SCALED AT 50%

For added stability and structure, adhere two sheets of felt together back to back before cutting out template pieces.

